

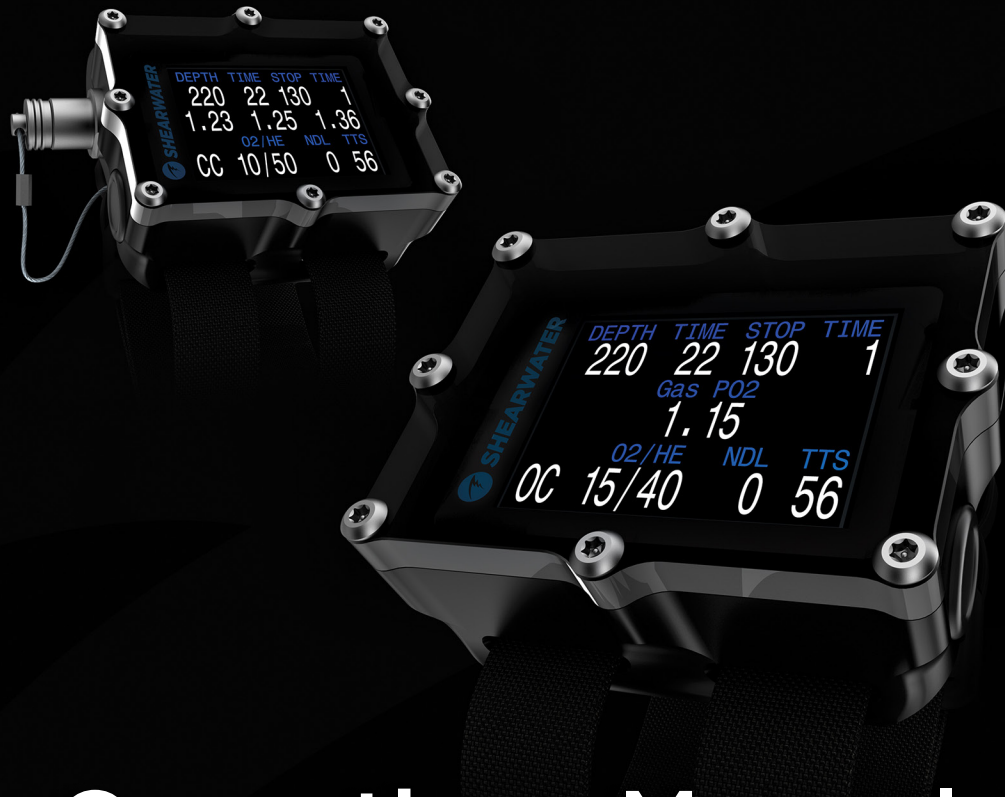

SHEARWATER **PETREL**



Operations Manual **Petrel 1 / Petrel 2**

Standalone & EXT Models



Powerful • Simple • Reliable

Table of Contents

Introduction	5
Models Covered by this Manual	5
Feature List.....	6
Turning On	7
Buttons	8
The Main Screen	9
Color Coding	9
The Top Row.....	10
The Center Row.....	12
Center Row Configuration.....	13
The Bottom Row	14
Info Screens	16
Compass (Petrel 2 only)	20
Menus	22
Open Circuit Menu Structure	23
Closed Circuit (Int. PPO2) Menu Structure.....	24
Closed Circuit (Ext. PPO2) Menu Structure.....	25
Basic Setup	26
Simple Example Dive	27
Complex Example Dive	28
Gauge Mode	31
Stopwatch	31
Resettable Average Depth.....	31
Decompression and Gradient Factors	32
Menu Reference	33
Turn Off.....	33
Calibration.....	33
Single Sensor Mode.....	34
Calibration Problems.....	34
Switch Setpoint	35
Select Gas	36
Radio Station Gases	36
Select Gas Menu Styles.....	37
Switch to OC/CC.....	38
Dive Setup+	38
Low Setpoint	38

Table of Contents (continued)

High Setpoint.....	39
Define Gas	40
Dive Planner+	42
Conservatism	44
NDL Display	45
External PPO2 Monitoring	47
Brightness	48
Dive Log Menu.....	49
Display Log	49
Upload Log.....	49
Edit Log Number	49
System Setup+	50
Dive Setup.....	51
Deco Setup	53
OC Gases	53
CC Gases	53
O2 Setup.....	54
Auto SP (Setpoint) Switch.....	54
Display Setup.....	55
Compass Setup (Petrel 2 only).....	57
System Setup.....	59
Advanced Configuration 1.....	60
Advanced Configuration 2.....	61
Firmware Upload and Dive Log Download.....	62
Changing the Battery	63
Battery Types.....	64
Tissues Cleared	65
Error Displays	66
Storage and Maintenance	68
Servicing	68
Fischer Pin-out	68
Specifications	69
FCC Warning.....	70
Industry Canada Warning	70

DANGER

This computer is capable of calculating deco stop requirements. These calculations are at best a guess of the real physiological decompression requirements. Dives requiring staged decompression are substantially more risky than dives that stay well within no-stop limits.

Diving with rebreathers and/or diving mixed gases and/or performing staged decompression dives and/or diving in overhead environments greatly increases the risk of scuba diving.

You really are risking your life with this activity.

WARNING

This computer has bugs. Although we haven't found them all yet, they are there. It is certain that there are things that this computer does that either we didn't think about, or planned for it to do something different. Never risk your life on only one source of information. Use a second computer or tables. If you choose to make riskier dives, obtain the proper training and work up to them slowly to gain experience.

This computer will fail. It is not whether it will fail but when it will fail. Do not depend on it. Always have a plan on how to handle failures. Automatic systems are no substitute for knowledge and training.

No technology will keep you alive. Knowledge, skill, and practiced procedures are your best defense (Except for not doing the dive, of course).

Introduction

The Shearwater Petrel is an advanced technical diving computer for open and closed circuit divers.

Although we strive to make the Petrel easy enough to use without reading the manual, please take some time to read this manual to get the best performance from your new computer. Diving involves risk and education is your best tool for managing this risk.

Models Covered by this Manual

This manual provides operating instructions for the Petrel **Standalone (SA)** and Petrel **External (EXT)** models. Both the Petrel 1 and Petrel 2 hardware versions are covered by this manual.

Nitrox Recreational (OC Rec) Mode

Operation of the Petrel when set to the "OC Rec" mode is covered by a separate manual, see the [Shearwater Petrel Nitrox Recreational Mode Manual](#). Although the model of Petrel is the same when using this mode, a separate manual was written to keep the instructions simple.

DiveCAN® (Rebreather Controller) Models

For instructions on the Petrel *rebreather controller models* using DiveCAN® communications, see the [Shearwater DiveCAN® Petrel Manual](#).

Petrel 1 vs. Petrel 2

This manual covers both the Petrel 1 and Petrel 2 models. The difference between the models is that the Petrel 2 has a digital compass and also supports Bluetooth Smart Ready (i.e. dual mode Bluetooth supporting both Bluetooth Classic v2.1 and Bluetooth Smart v4.0). Bluetooth Smart is used for connecting to iOS devices.

All other features are the same between the Petrel 1 and Petrel 2. Both models use the same firmware file and firmware version number.

Feature List

- Depth, time and oxygen sensor display
- Bühlmann decompression model with gradient factors conservatism
- Optional VPM-B decompression model
- Imperial and metric displays
- Available in Standalone (SA) model and External (EXT) PPO2 monitoring model
- A menu system that adapts to diving status
- Automatic turn off after 15 minutes on the surface
- Depth sensor rated to 450 feet/140 meters of seawater
- Dive Planner
- Any combination of oxygen, nitrogen, and helium (Air, Nitrox, Trimix)
- Open and closed circuit, switchable during a dive
- 5 CC and 5 OC gases
- Gases can be changed and added during a dive
- CNS tracking
- No lockout from violating deco stops
- Automatic PPO2 set-point switching (configurable)
- Two PPO2 set-points, each of which can be set between .4 and 1.5
- Flexible user replaceable battery. Almost any 'AA' type
- Tilt compensated digital compass (Petrel 2 only)
- 1000 hour dive log memory
- Log downloads and firmware upgrades using Bluetooth

Turning On

To turn the Petrel on, press both the MENU (left) and the SELECT (right) buttons at the same time.

Buttons

Two piezo-electric buttons are used to change settings and view menus. Except for turning the Petrel on, all operations are simple single button presses.

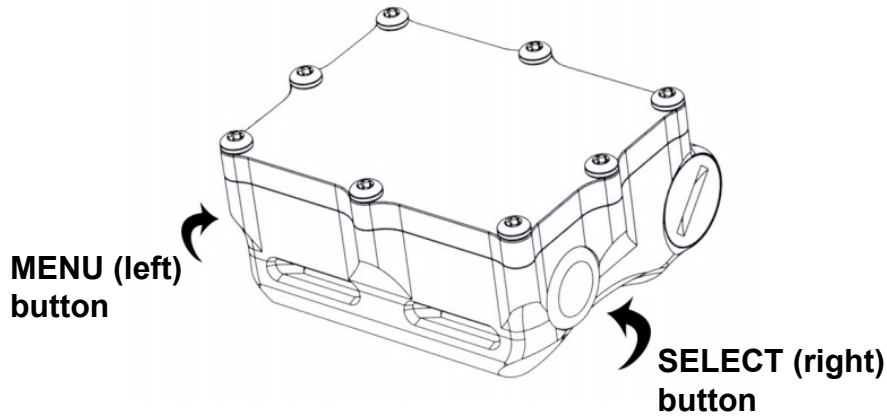

Don't worry about remembering all the button rules below. Button hints make using the Petrel easy.

MENU button (Left)

- **From main screen:** brings up the menu.
- **In a menu:** moves to the next menu item.
- **Editing a setting:** changes the setting's value.

SELECT button (Right)

- **From main screen:** steps through information screens.
- **In a menu:** performs command or starts editing.
- **Editing a setting:** saves the setting's value.

BOTH BUTTONS

- **When Petrel is off:** pressing MENU and SELECT at the same time will turn the Petrel on.
- No other operation requires pressing both buttons at the same time.



Button Hints

When in a menu, button hints label each button.

For example, the hints to the right tell us:
use MENU to **change** the brightness value.
use SELECT to **save** the current value.

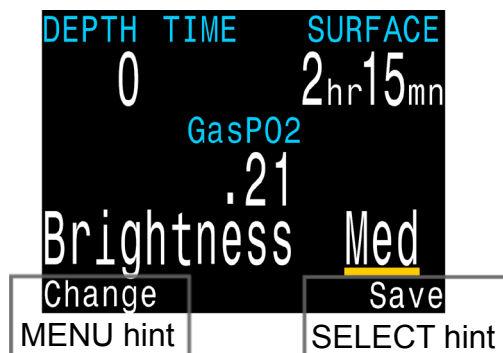

The Main Screen



Top Row
Depth, Time &
Deco Stops

Center Row
PPO2

Bottom Row
Mode, Gas &
Deco Info

The main screen shows the most important information needed for technical diving.

Color Coding

Color coding of text draws attention to problems or unsafe situations.

White text indicates normal conditions.

YELLOW is used for warnings that are not immediately dangerous but should be addressed.

FLASHING RED is used for critical alerts that could be life threatening if not immediately addressed.



Sample warning -
a better gas is available

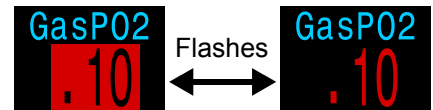

Sample critical alert -
continuing to breathe this
gas could be fatal

Color Blind Users

The warning or critical alert states can be determined without the use of color.

Warnings display on a solid inverted background.

Critical alerts flash between inverted and normal text.



Warning - doesn't flash

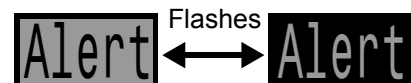

Critical alert - flashes

The Top Row



The top row shows depth and time information

Depth

Imperial: In feet (no decimal places).

Metric: In meters (displays with 1 decimal place up to 99.9m)

Note: If the depth shows a **Flashing Red** zero, then the depth sensor needs service.



in feet



in meters

Ascent Bar Graph

Shows how fast you are currently ascending.

Imperial: 1 arrow per 10 feet per minute (fpm) of ascent rate.

Metric: 1 arrow per 3 meters per minute (mpm) of ascent rate.

White when 1 to 3 arrows, **Yellow** when 4 to 5 arrows, and **Flashes Red** when 6 arrows or more.

Note: Deco calculations assume 33fpm (10mpm) ascent rate.

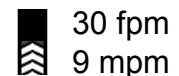

30 fpm
9 mpm

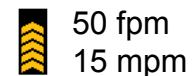

50 fpm
15 mpm

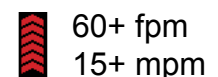

60+ fpm
15+ mpm

Dive Time

The length of the current dive in minutes.

The seconds display as a bar drawn below the word "Time." It takes 15 seconds to underline each character in the word. Does not display the seconds bar when not diving.



in minutes



seconds bar
at about 45s

Battery Icon

Yellow when the battery needs to be changed.

Red when the battery must be replaced immediately.

The default behavior is that battery icon is shown on the surface but disappears when diving. If low or critical then the battery icon will appear while diving.



OK

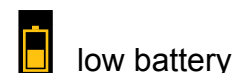

low battery

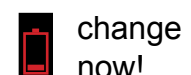

change
now!

Shearwater Petrel SA & EXT

Stop Depth and Time

Stop – The next stop depth in the current units (feet or meters).
This is the shallowest depth to which you can ascend.
Time – The time in minutes to hold the stop.



Stop at 90ft for 2 min

Will **Flash Red** if you ascend shallower than the current stop.



Alert - depth is shallower than the 90ft stop depth

By default the Petrel uses a 10ft (3m) last stop depth. At this setting, you may perform the last stop at 20ft (6m) with no penalty. The only difference is that the predicted time-to-surface will be shorter than the actual TTS since off-gasing is occurring slower than expected.

There is also an option to set the last stop to 20ft (6m) if you wish.

Surface Interval

When on the surface, the STOP DEPTH and TIME are replaced by a surface interval display.



Shows the hours and minutes since the end of your last dive. Above 4 days, the surface interval is displayed in days.

The surface interval is reset when the decompression tissues are cleared. See the section on Tissues Cleared.

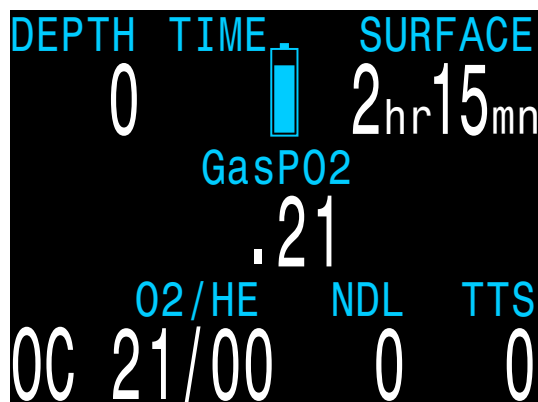

Sample surface main screen showing the surface interval

The Center Row

The center row displays **PPO2**. PPO2 units are absolute atmospheres (1ata = 1013mbar).

The layout varies depending on the current mode:

Mode	Menu Setup	Center Row Display
Open Circuit	<pre> Dive Setup Mode OC Salinity Fresh Next Edit </pre>	<pre> GasP02 1.15 OC Gas </pre>
Closed Circuit with Internal PPO2 Setpoints	<pre> Dive Setup Mode OC/CC Salinity Fresh PPO2 Mode Int. Low SP 0.7 High SP 1.3 Next Edit </pre>	<pre> 1.3 CC Internal Setpoint </pre>
Closed Circuit with External PPO2 Monitoring (Only available on EXT model)	<pre> Dive Setup Mode OC/CC Salinity Fresh PPO2 Mode Ext. Next Edit </pre>	<pre> 1.29 1.31 1.28 CC External Measured </pre>

In CC mode, PPO2 displays in **Flashing Red** when less than 0.40 or greater than 1.6.

In OC mode, PPO2 displays in **Flashing Red** when less than 0.19 or greater than 1.65.

The above limits can be adjusted in the Adv. Config 2 menu.

Center Row Configuration

In most modes, the center row displays can be customized.

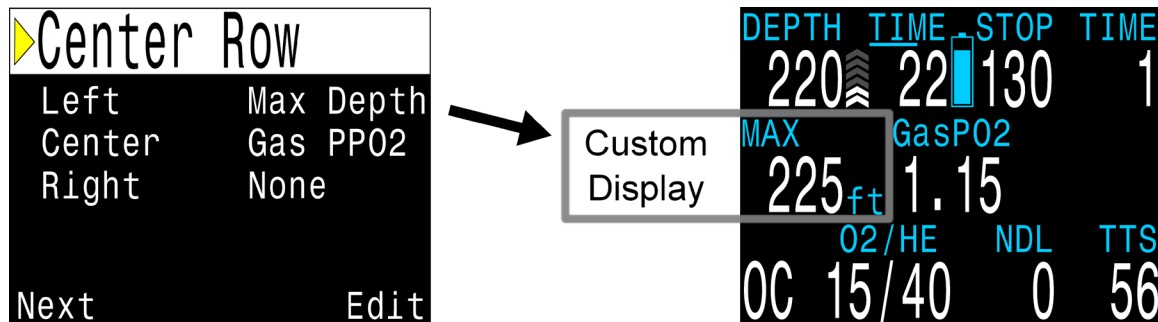

Configure the center row in the System Setup → Center Row Menu.

The left and right positions can be set to display the following:

Option	Description
None	Blank (default value).
Max Depth	The maximum depth of the current or previous dive.
Avg Depth	The average depth of the current or previous dive.
@+5	The TTS if remaining at current depth for 5 more minutes.
Ceil	The current decompression ceiling (not rounded to the stop interval).
GF99	The Bühlmann ZHL-16C super-saturation percent gradient.
CNS	Central Nervous System (CNS) toxicity clock as a percentage.
Clock	The time-of-day in 24hr or am/pm format (same as system setting). Does not show "am" or "pm".
DET	Dive End Time. The time-of-day when the dive will end (i.e. Clock plus TTS). In 24hr or am/pm format (same as system setting). Does not show "am" or "pm".
Dil PPO2	The diluent PPO2 at the current depth (Only available when CC is available).
FiO2	The fraction of inspired O2 as a percentage (Only available when CC or SC is available).

The center position can only display PPO2. In OC only mode, the PPO2 display can optionally be turned off.

Unfortunately, customization is not possible when using External PPO2 monitoring of three O2 sensors, as all the space is already used.

The Bottom Row

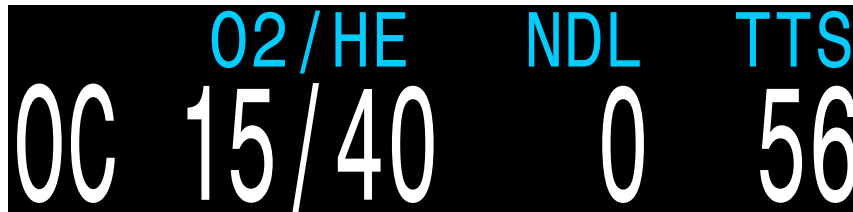

The bottom row displays the current mode, gas and decompression information.

Circuit Mode

The current breathing configuration. One of:
 OC = Open circuit (when CC available, displays in **Yellow** to indicate bailout condition)
 CC = Closed circuit
 SC = Semi-closed circuit (only available on EXT model)

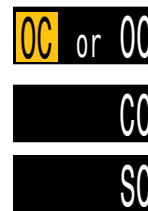

Current Gas (O2/He)

The current gas shown as a percentage of Oxygen and Helium. The remainder of the gas is assumed to be Nitrogen.



In closed circuit mode, this gas is the diluent. In open circuit mode this is the breathing gas.

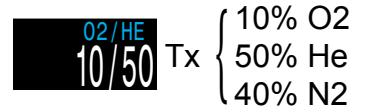

Displays in **Yellow** when there is better deco gas available than the current gas.



No Decompression Limit (NDL)

The time remaining, in minutes, at the current depth until decompression stops will be necessary. Displays in **Yellow** when the NDL is less than 5 minutes.



Once NDL reaches 0 (i.e. deco stops needed), the NDL display is just wasting space. To address this, a few different values can be set to replace the NDL (see Dive Setup → NDL Display). The options are:

CEIL: The current ceiling in the current units (feet or meters). **Flashes Red** if you ascend shallower than the current ceiling.



Shearwater Petrel SA & EXT

GF99: The raw percentage of the Bühlmann allowable supersaturation at the current depth.

GF99
80%

@+5: The predicted time-to-surface (TTS) if you were to stay at the current depth for 5 more minutes.

@+5
20

Time-to-Surface (TTS)

The time-to-surface in minutes. This is the current time to ascend to the surface including the ascent plus all required deco stops.

TTS
35

Assumes:

- Ascent rate of 33 feet per minute (10 meters per minute).
- Decompression stops will be followed.
- Programmed gases will be used as appropriate.

The bottom row is also used to show additional information.

By using only the bottom row for this additional information, the critical information contained on the Top and Center Rows is always available during a dive.

The additional information that can be displayed on the bottom row includes:

- Info:** Shows additional dive information.
Screens: Press SELECT (right button) to step through info screens.
- Menus:** Allows changing settings.
 Press MENU (left button) to enter menus.
- Warnings:** Provide important alerts.
 Press SELECT (right button) to clear a warning.

DEPTH	TIME	STOP	TIME
220	22	130	1
GasP02			
1.15			
MAX	AVG	AvgATM	
234ft	190ft	6.76	

DEPTH	TIME	STOP	TIME
220	22	130	1
GasP02			
1.15			
Brightness			
Change		Med	
Save			

DEPTH	TIME	STOP	TIME
62	38	70	2
GasP02			
1.42			
Error			
MISSED		CONFIRM	
DECO STOP			

Sample Info Screen

Sample Menu

Sample Warning

The bottom row is used to display additional information

Info Screens



Info screens display on the bottom row.

Press SELECT (right) button to step through the info screens.

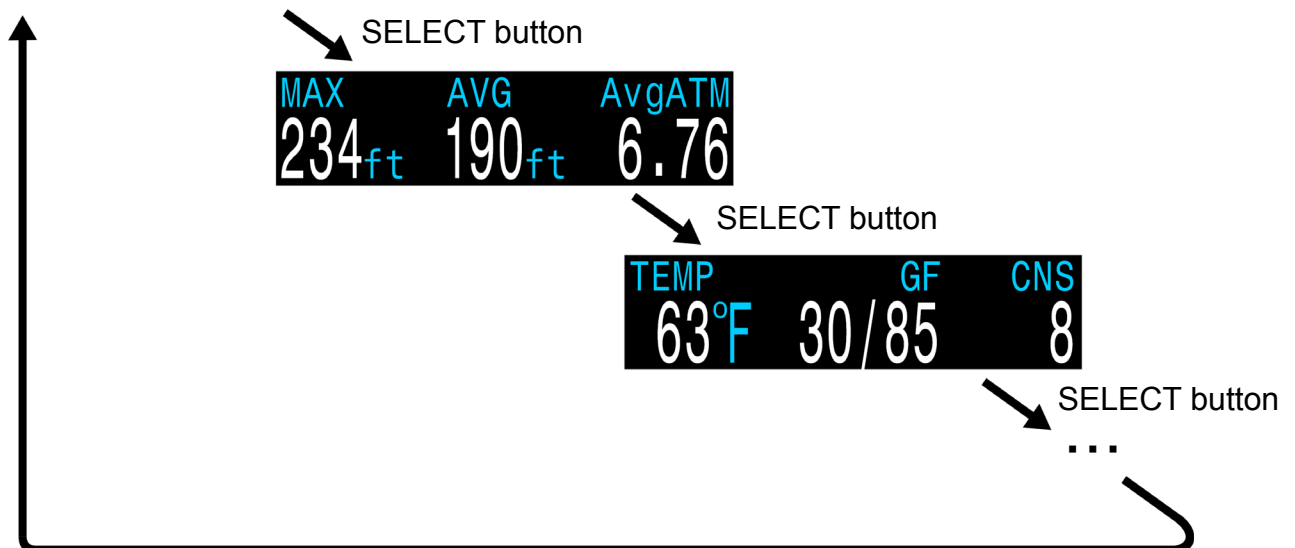

Info screens provide additional information that does not fit on the main screen.

Starting from the main screen, the SELECT (right) button steps through the info screens.

When all info screens have been viewed, pressing SELECT again will return to the main screen.

Info screens time-out after 10 seconds, returning to the main screen. Pressing the MENU (left) button will also return to the main screen.

The info screen content is optimized for each mode. Set the Petrel to the mode you will be using (e.g. OC) and step through the info screens to get familiar with the content.

The next section describes the individual values shown on the info screens.

Shearwater Petrel SA & EXT

Average Depth

Displays the average depth of the current dive, updated once per second.

When not diving, shows the average depth of the last dive.



AVG
50 ft

Average Depth in Atmospheres (AvgATM)

The average depth of the current dive, measured in absolute atmospheres (i.e. a value of 1.0 at sea level). When not diving, shows the average depth of the last dive.



AvgATM
2.52

Maximum Depth

The maximum depth of the current dive.

When not diving, displays the maximum depth of the last dive.



MAX
260 ft

CNS Toxicity Percentage

Central Nervous System oxygen toxicity loading percentage. **Flashes Red** when 100 or greater.



CNS
11

The CNS percentage is calculated continuously, even when on the surface and turned off. When deco tissues are reset, the CNS will also be reset.



CNS
100

PPO2 (average PPO2)

Only relevant when external PPO2 monitoring is used, since other modes already show PPO2 on the center row.

The purpose of this value is to show what PPO2 is actually being used for decompression calculations.



PPO2
.98

When three external sensors are used, the Petrel votes on the three measured values to decide what is the most likely true PPO2. This value shows the result of the voting.

Also, when using external sensors and you have bailed out to OC, the center row continues to display the external measured PPO2. Use this info display to see the OC PPO2.

In CC mode, displays in **Flashing Red** when less than 0.40 or greater than 1.6.



PPO2
.36

In OC mode, displays in **Flashing Red** when less than 0.19 or greater than 1.65.



PPO2
.16

Diluent PPO2

Only displayed in CC mode. Displays in **Flashing Red** when the partial pressure of the diluent is less than 0.19 or greater than 1.65.



When performing a manual diluent flush, you can check this value to see what the expected PPO2 will be at the current depth.

Fraction Inspired O2 (FiO2)

The fraction of the breathing gas composed of O2. This value is independent of pressure.



Tissues Bar Graph

The tissues bar graph shows the tissue compartment inert gas tissue tensions based on the Bühlmann ZHL-16C model. Note that VPM-B also tracks tensions in the same way.

The fastest tissue compartment is shown on the top, and the slowest on the bottom. Each bar is the combined sum of the nitrogen and helium inert gas tensions. Pressure increases to the right.

The vertical black line shows the inert gas inspired pressure. The boundary between the green and yellow zones is the ambient pressure. The boundary between the yellow and red zone in the ZHL-16C M-Value pressure.

Note that the scale for each tissue compartment above the green zone is different. The reason the bars are scaled in this way is so that the tissues tensions can be visualized in terms of risk (i.e. how close they are as a percentage to Bühlmann's original super-saturation limits). Also, this scale changes with depth, since the M-Value line also changes with depth.

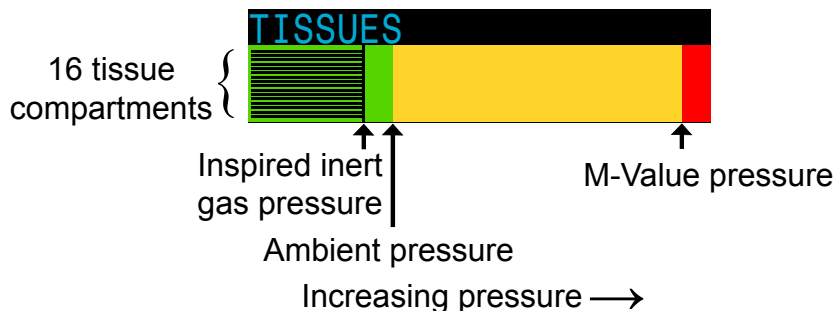

Some Sample Tissues Graphs



Shearwater Petrel SA & EXT

Gradient Factor:

The deco conservatism value when the deco model is set to GF. The low and high gradient factors control the conservatism of the Bühlmann GF algorithm. See “Clearing up the Confusion About Deep Stops” by Erik Baker.



GF
30/85

VPM-B (and VPM-BG):

The deco conservatism value when the deco model is set to VPM-B.

If the deco model is VPM-B/GFS, also displays the gradient factor for surfacing.



VPM-B
+3



VPM-BG
+3/90

Pressure:

The pressure in millibars. Two values are shown, the surface (surf) pressure and the current (now) pressure.

The current pressure is only shown on the surface.

The surface pressure is set when the Petrel is turned on. If the Altitude setting is set to SeaLvl, then surface pressure is always 1013 millibars.



PRESSURE mBar
SURF 1013 NOW 1011

Temperature:

The current temperature in degrees Fahrenheit (when depth in feet) or degrees Celsius (when depth in meters).



TEMP
73°F

Battery:

The Petrel's internal battery voltage. Displays in **Yellow** when the battery is low and needs replacement. Displays in **Flashing Red** when the battery is critically low and must be replaced as soon as possible. Also shows battery type.



BATTERY
3.7V
LiIon 3.99V

Millivolts:

The raw millivolt readings from the PPO2 sensors. Only available when external PPO2 monitoring is used.



Millivolts
42.0 46.0 43.0

Date and Time:

In the format dd-mon-yy
12 or 24 hour clock time.



DATE TIME
28-Jun-12 16:31



DATE TIME
28-Jun-12 4:31 pm

Serial Number & Version:

Each Petrel has a unique serial number.

The version number indicates the available features. The last two numbers are the firmware version (V12 in this image).



SERIAL NO VERSION
1234ABCD 2000012

Compass (Petrel 2 only)

The Petrel 2 model contains a tilt-compensated digital compass.

Compass features:

- 1° resolution
- ±5° accuracy
- Smooth, high-speed refresh rate
- User set heading marker with reciprocal
- True North (declination) adjustment
- Tilt compensation ±45°



Viewing the Compass

When enabled, the compass is viewed by pressing the SELECT (right) button once. Press SELECT again to continue on to view the regular info screens.

Unlike the regular info screens, the compass never times out back to the main screen. Press MENU (left) button to return to the main screen.



Compass Limitations

It is important to understand some compass limitations before use.

Calibration - The digital compass needs occasional calibration. This can be done in the System Setup → Compass menu and takes only one minute.

Battery Changes - When the battery is changed, the compass should be calibrated. This is because each battery has its own magnetic signature that interacts with the compass. Fortunately this effect can be removed with proper calibration.

Interference - Since a compass operates by reading the Earth's magnetic field, the compass heading is affected by anything that distorts that field or creates its own.

- Ferromagnetic materials (such as iron, steel, or nickel) should be kept away from the Petrel 2 when using the compass.
- A traditional compass should also not be placed too close, as it contains a permanent magnet.
- Electric motors and high current cabling (such as from dive lights) can also cause interference and should be kept at a distance.
- Being inside or near a shipwreck may also affect the compass heading.

Marking a Heading

To mark a heading, press MENU (left) button until "Mark Compass" is displayed, then press SELECT (right) button to mark the current direction. The display will then jump back to the compass display. The heading is shown as a pair of green triangles.

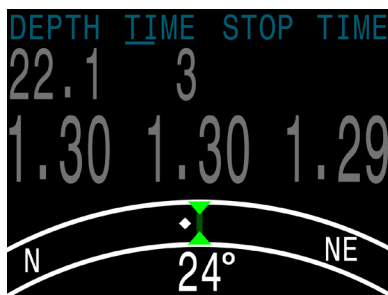

Mark the heading to remember the current direction



This feature makes it easy to determine if you are off course



When the marked heading is off screen, an arrow points the shortest way back



When facing the opposite direction, the reciprocal heading is shown as a pair of red triangles

Only one heading can be marked at a time, it can however be changed. Once a heading has been marked, there is no way to clear the heading arrows from the display.

Menus



Press MENU (left) button to step through the menus.

Press SELECT (right) button to execute command or enter sub-menu.

Menu display on the bottom row.

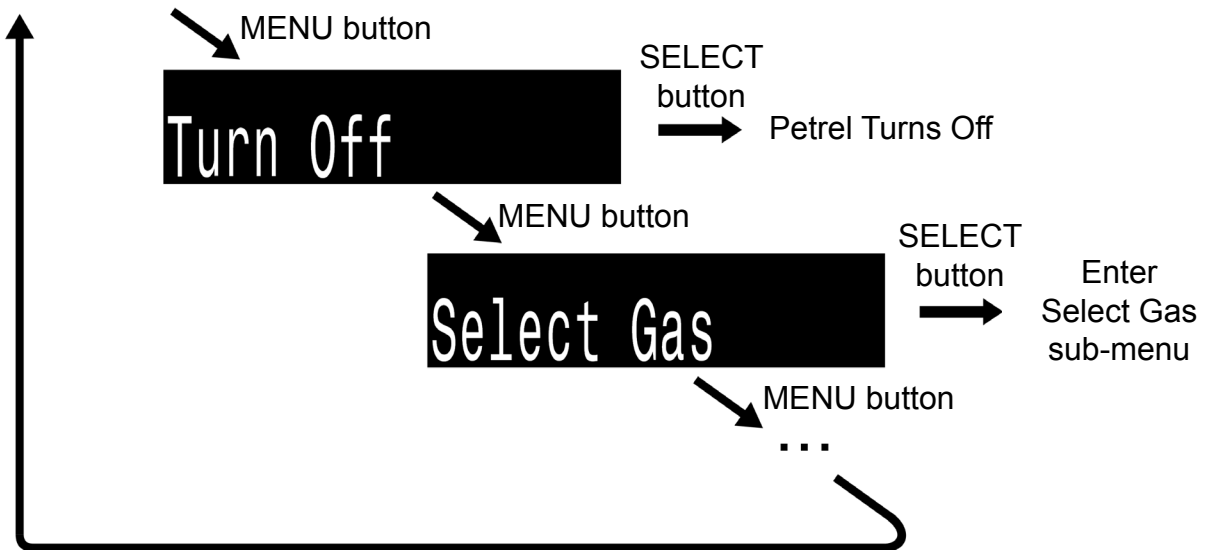

Menus perform actions and allow settings to be changed

Starting from the main screen, pressing the MENU (left) button steps through the menus. When all menus have been viewed, pressing MENU again will return to the main screen.

Pressing the SELECT (right) button when a menu is displayed, either performs that action or enters a sub-menu.

If no buttons are pushed for 1 minute, the menu system will time-out, returning to the main screen. Anything that had been previously saved will be retained. Anything that was in the middle of editing will be discarded.



Adaptive Menus

Only menus necessary for the current mode are shown. This keeps operation simple, prevents mistakes, and reduces button presses.

The following sections show the menu structure in various operating modes.

Open Circuit Menu Structure

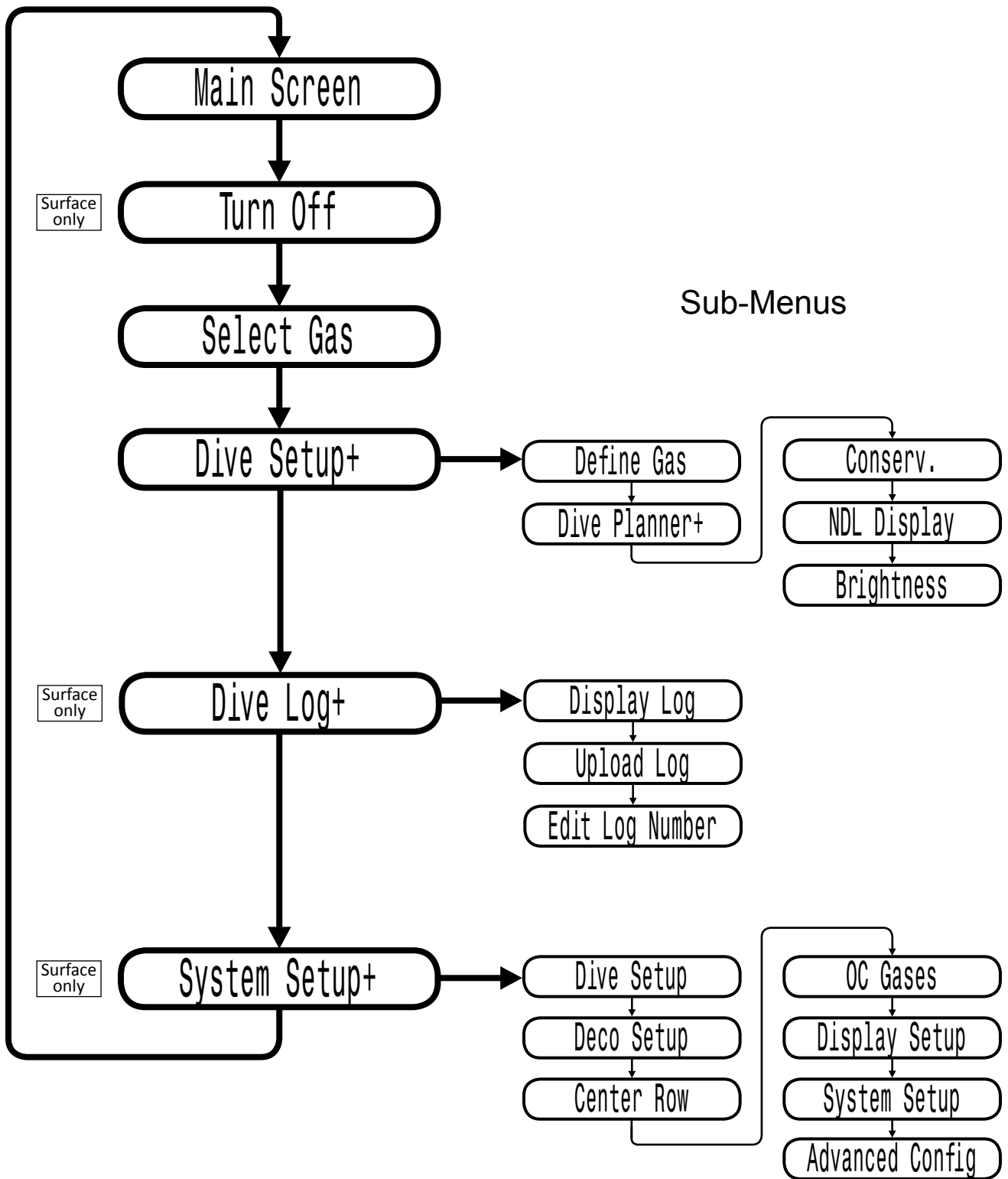

Closed Circuit (Int. PPO2) Menu Structure

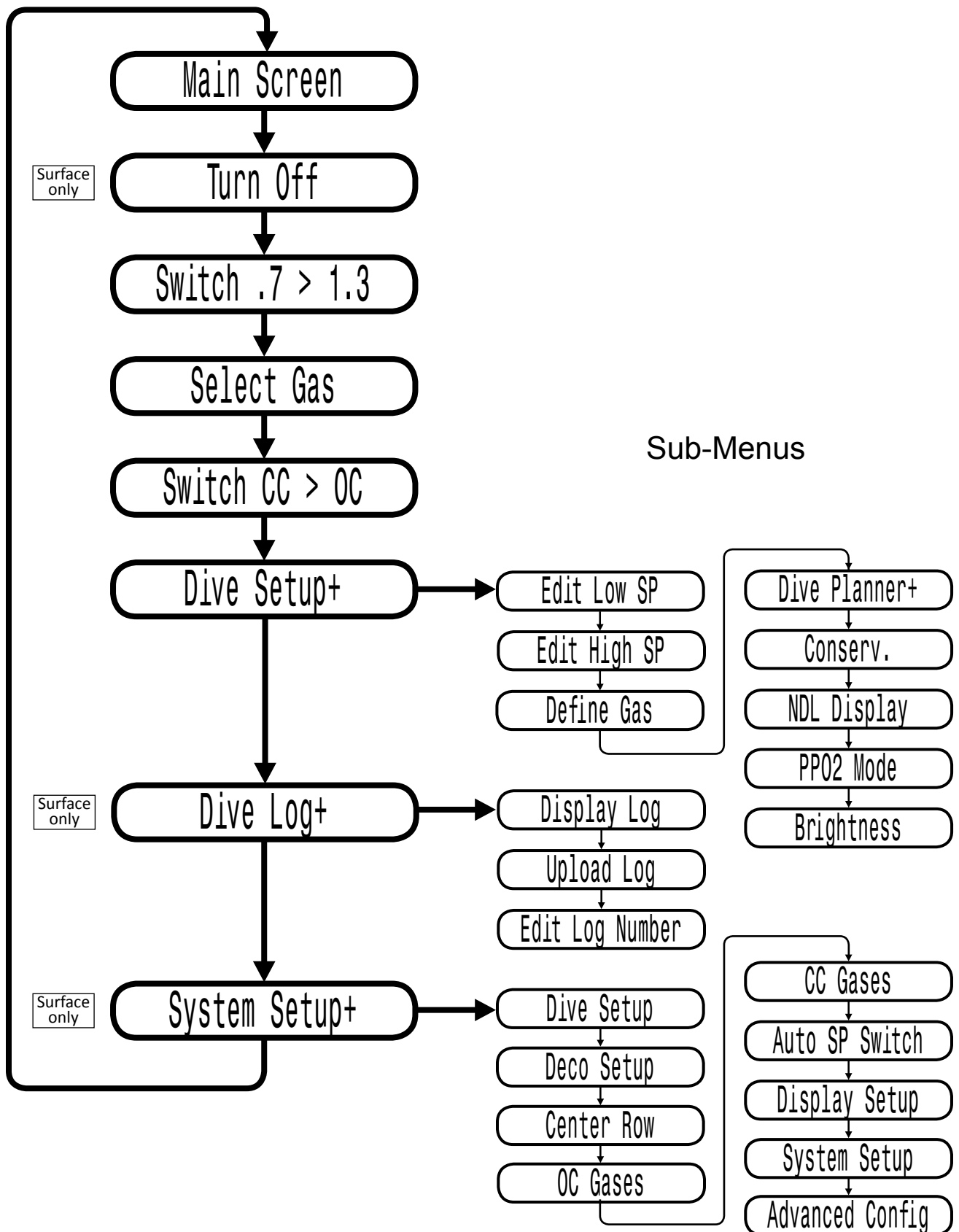

Closed Circuit (Ext. PPO2) Menu Structure

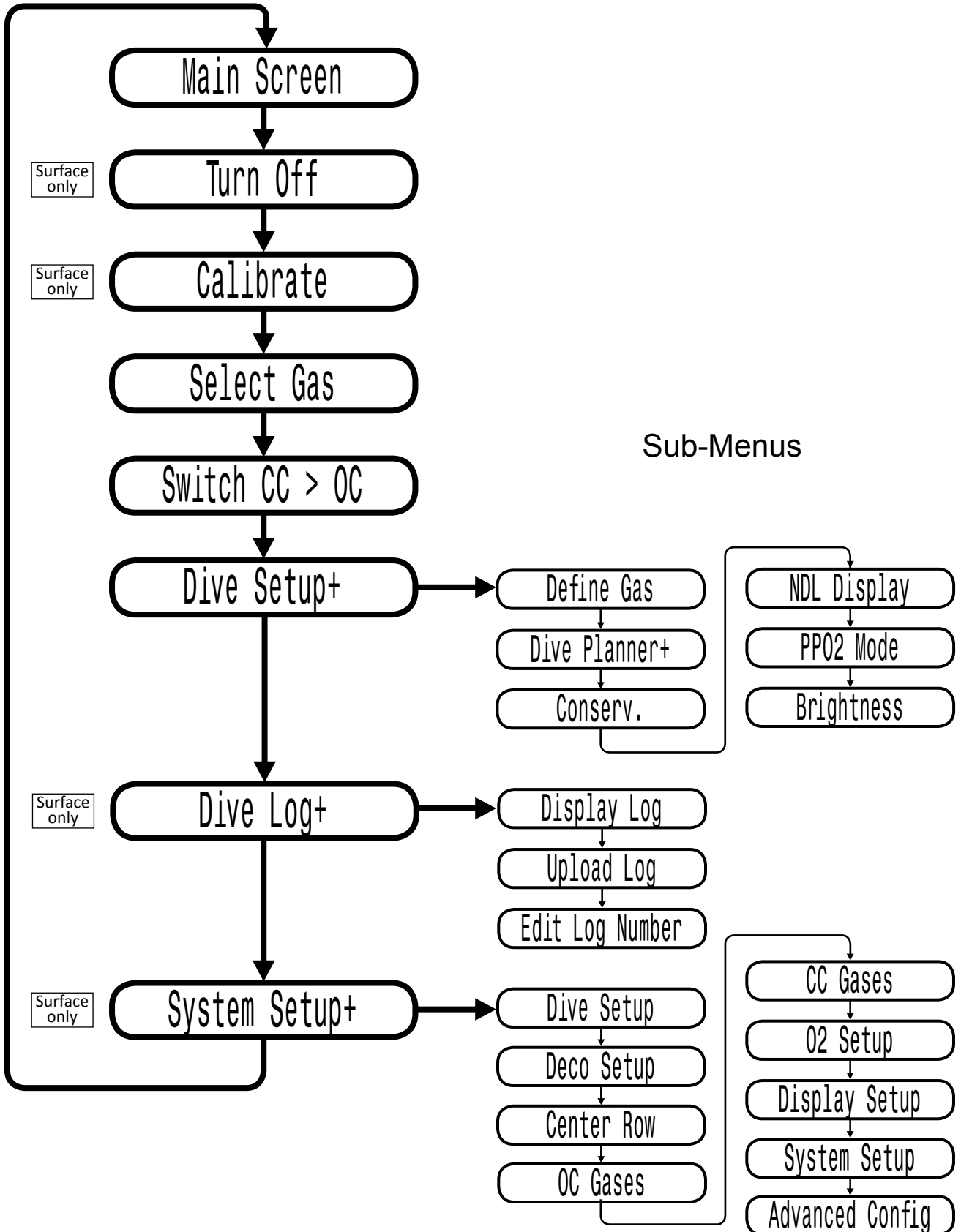

Basic Setup

Before using the computer there are several things that need to be configured. This is not an exhaustive list of the pre-requisites for diving the system, but a suggestion of key tasks.

- On a system with external oxygen sensors, **calibrate the oxygen sensors**.
- In the System Setup menu **set the units** to metric or imperial, also set the date and time.
- Depending on the model of computer, **enter the gases** that you will use for the closed circuit portion of your dive, and/or enter the gases for you will use for open circuit.
- The system will use the gases that are available in the order of oxygen content during the Time To Surface (TTS) prediction. The system will use the next available gas that has a PPO2 of less than 1.0 for closed circuit diving.
- If the computer is in open circuit or is switched to open circuit during a dive, the system will calculate the TTS based on the configured open circuit gases that are available. It will use the next available gas that has a PPO2 of less than 1.6 for open circuit diving.

NOTE: These gases are used automatically only for TTS predictions. The gas used to calculate the current tissue load and the current ceiling is always the gas actually selected by the diver.

Simple Example Dive

Here is an example of a simple OC air dive. It will help to introduce the screen displays as the diver progresses, the dive starts, the depth increases. The display is showing the computer programmed for open circuit (OC) air.

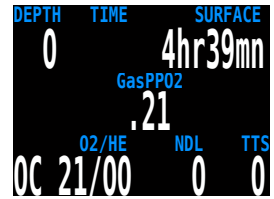

As we pass through 30 feet, the time-to-surface (TTS) shows one minute. This shows that the computer is expecting the diver to ascend at approximately 30 feet per minute or 10 meters per minute. The dive predictions are based on this ascent rate.



The no-decompression limit (NDL) starts off showing 99, but then starts to show a smaller number as the depth increases. The 3rd screen shows that we will go into deco in 12 minutes.



We have now entered decompression. Our first stop, or ceiling, is at 20 feet and we will need to remain there for up to one minute. Although stops are shown in minutes, the computer will calculate and change the ceiling in real time and the stop may be less than a minute.

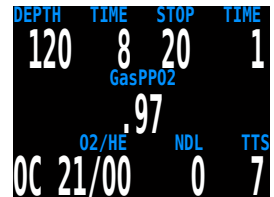

As we ascend, the ascent rate indicator shows about 20 fpm or 6 mpm.



When we go shallower than our first stop, the stop depth starts to flash red.



When we clear the last stop, the stop depth and time goes blank, and now we see a NDL of 99 minutes again. Once we surface, the depth is 0 and a minute later when the computer comes out of dive mode, the NDL goes to 0 as well.



Complex Example Dive

This is an example of the displays that might be seen on a dive. This example shows a complicated dive with multiple Closed Circuit (CC) gases and multiple Open Circuit (OC) bail-out gases. A normal, single gas CC or OC dive wouldn't have any button pushes at all, so there isn't much to show.

The first step is to calibrate. Since we are on the surface and not diving, MENU will bring up "Turn Off", then "Calibrate." Once the loop is flushed with oxygen, SELECT will bring up the confirmation display, and another SELECT will calibrate.

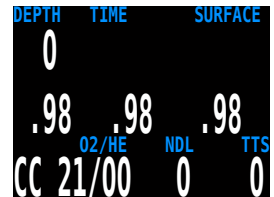
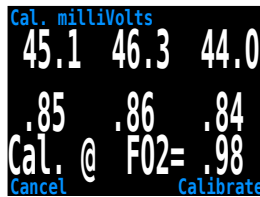

Next, we check the closed circuit diluent gases that we have programmed. Entering the gas selection function by pressing SELECT with the "Select Gas" menu item showing will display the first CC gas that is available. MENU will increment to the next gas available. Another MENU takes us back to the "Select Gas" menu item. Those are the only two gases configured. We SELECT gas number 2, the Trimix 10/50.

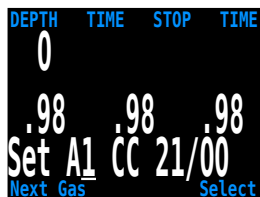

The system will use both of these gases for our dive when calculating the TTS. It assumes a diluent switch at a PPO2 of 1.05. That means that it will assume that you have switched to an air diluent at 124 feet. This is only for the TTS prediction. The computer will always use the currently selected gas for tissue loading calculations.

Then we switch to open circuit to look at our bail-out gases. Flipping through the gases with MENU shows that we have three gases available. (Whether they are appropriate gases is a subject for one of the web forums.)

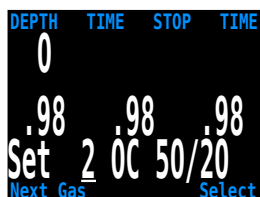
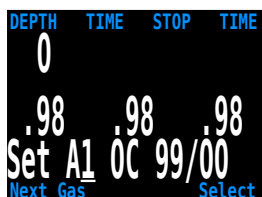

Shearwater Petrel SA & EXT

These are the gases that will be used to estimate TTS in the event that you switch to open circuit during a dive. In OC mode, the computer will assume that you will switch gases when the PPO2 of the next available gas is less than 1.6.

Automatic decisions of when to switch gases for the TTS calculation means that it is very easy to set up your CC and OC gases. There is no need to enter a depth or a PPO2 to switch gas. Any gases that are turned on will be used in the decompression calculation.

If a gas is available in the CC gas list, (entered and turned on), it will be used in CC, and it will be used at an appropriate depth. The same is true for OC. It is always configured correctly if you are actually carrying the gases you have entered and turned on.

If it is necessary to switch to OC while diving, 4 button pushes will do it. You will be switched to OC and will be using the gas that has the highest PPO2 less than 1.61. Your OC gas list is likely very different from your diluent gas list, but you set it up before the dive so it is immediately available in the case of a bail-out.

Now switch back to closed circuit and start the dive.



We have reached a depth now that will incur decompression soon. The ND is 8 minutes, and the TTS is 4 minutes. The TTS is showing the planned ascent time at 30 fpm.

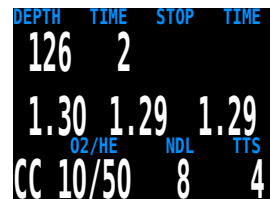

The computer has automatically switched to the high setpoint. This can be disabled if automatic setpoint switching isn't required.

We are now at our maximum depth. Our first stop is at 90 feet.



The diver is ascending to the 90 foot stop. Note the ascent rate indicator showing a 20 fpm / 6 mpm ascent rate. The Petrel assumes a 30 fpm ascent rate in calculating the decompression schedule. Since the diver ascended slower than was predicted, there is now a 100 foot stop.

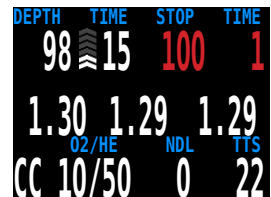

Shearwater Petrel SA & EXT

But the diver missed the stop, and has ascended to 95 feet. At this point, the stop depth and time is flashing red to show that the depth is above the recommended stop.

DEPTH	TIME	STOP	TIME
95	15	100	1
1.30	1.29	1.29	
CC	10/50	0	22

The diver switches to the other programmed CC gas. Note that if you change the diluent on the computer you must flush the loop to change the diluent in the loop. At the same time the 100 foot stop clears. It is common for the first stops to clear in less than a minute. They mainly just slow down the ascent.

DEPTH	TIME	STOP	TIME
95	15	90	1
1.30	1.30	1.29	
CC	21/50	0	22

At 60 feet a problem develops that causes the diver to bail out to open circuit. The first push on MENU brings up Select Gas.

DEPTH	TIME	STOP	TIME
60	19	60	1
1.30	.99	1.29	
Select Gas			

The second push brings up Switch CC > OC. A push on SELECT does the switch.

DEPTH	TIME	STOP	TIME
60	19	60	1
1.30	1.00	1.29	
Switch CC > OC			

Note that OC displays in Yellow to clearly indicate that this is a OC bailout condition.

The system has switched the gas set from the closed circuit gas set to the open circuit gas set, picked the gas with the highest PPO2 less than 1.6, and recalculated the decompression based on the new profile.

DEPTH	TIME	STOP	TIME
60	19	60	1
1.30	1.09	1.29	
OC	50/20	0	36

At 20 feet, one push on MENU brings up select gas.

DEPTH	TIME	STOP	TIME
20	25	20	3
.87	.95	.79	
Select Gas			

A push on SELECT enters the select gas menu, and another SELECT picks the O2. Since the gases are sorted by oxygen content, the O2 is the first gas offered.

DEPTH	TIME	STOP	TIME
20	25	20	3
.87	.95	.79	
Set	1	OC	99/00
Cancel			Select

This was a multi-gas trimix dive with a multi-gas open circuit bailout, and it required 9 button pushes.

Gauge Mode

Gauge Mode turns the Petrel into a simple depth and time display (a.k.a. a bottom timer).

Change to Gauge Mode in the System Setup → Dive Setup menu.

Since decompression tissues are not tracked in Gauge Mode, changing to or from Gauge Mode resets the deco tissues.

Features:

- Extra-Large Depth Display (in feet or meters)
- Extra-Large Time Display (in minutes:seconds)
- Maximum and Average Depth on main screen.
- Stopwatch
- Resettable Average Depth

The Gauge display is organized as.

- Depths along the left.
- Times along the right.
- Most important information (Depth, Dive Time) on the top row.

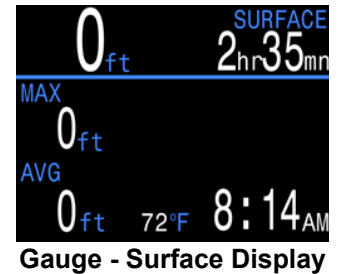

Gauge - Surface Display

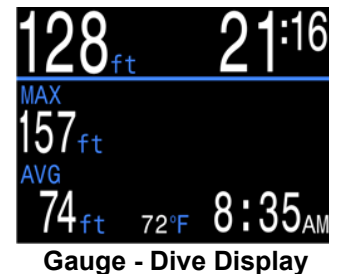

Gauge - Dive Display

Stopwatch

The Stopwatch is only available in Gauge Mode.

When diving, starting or stopping the Stopwatch is the first menu option.

When stopped, the word “Stopwatch” displays in red.

When non-zero, the stopwatch can be reset. Reset behavior depends on state:

- If running when reset, it continues running, counting up again from 0.
- If stopped when reset, then it is set 0 and remains stopped.

Resettable Average Depth

During a dive, the average depth can be reset.

While on the surface, the MAX and AVG values display the maximum and average depth of the last dive. The AVG depth displayed on the surface is for the entire dive, regardless of whether the reset average depth option was used. The dive log also records the average depth for the entire dive.



Stopwatch Running

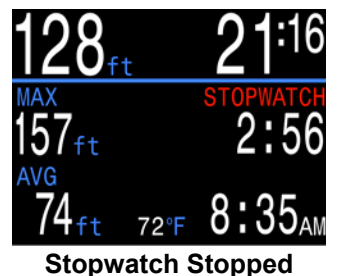

Stopwatch Stopped

Decompression and Gradient Factors

The basic decompression algorithm used for the computer is Bühlmann ZHL-16C. It has been modified by the use of Gradient Factors that were developed by Erik Baker. We have used his ideas to create our own code to implement it. We would like to give credit to Erik for his work in education about decompression algorithms, but he is in no way responsible for the code we have written.

The computer implements Gradient Factors by using levels of conservatism. The levels of conservatism are pairs of number like 30/70. For a more detailed explanation of their meaning, please refer to Erik Baker's excellent articles: *Clearing Up The Confusion About "Deep Stops"* and *Understanding M-values*. The articles are readily available on the web. You might also want to search for "Gradient Factors" on the web.

The default of the system is 30/70. The system provides several settings that are more aggressive than the default.

Don't use the system until you understand how it works.

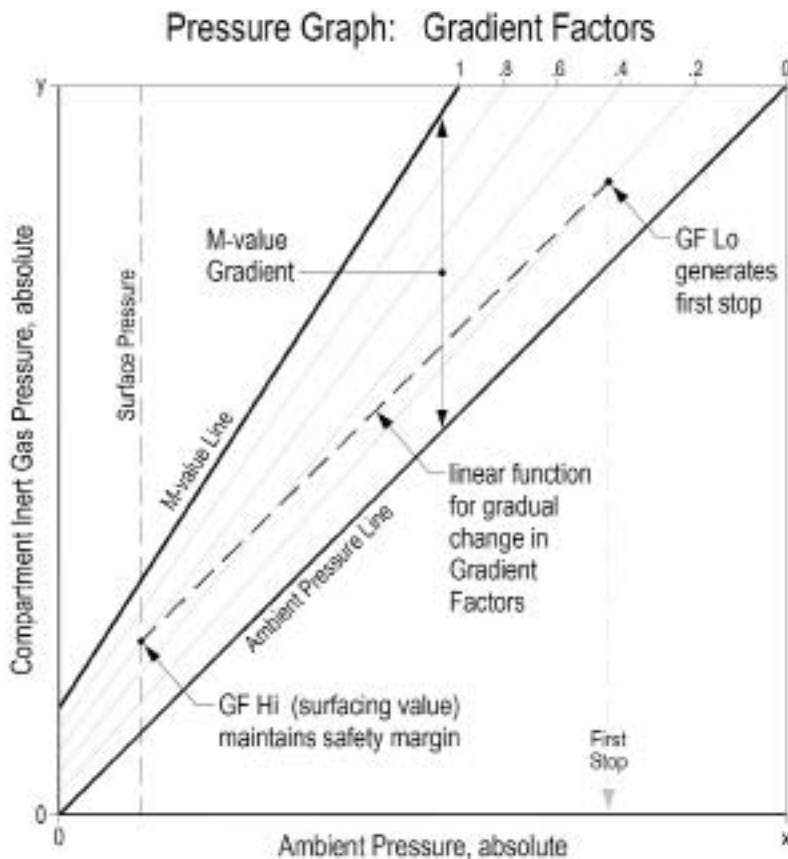

A Gradient Factor is simply a decimal fraction (or percentage) of the M-value Gradient.

Gradient Factors (GF) are defined between zero and one, $0 \leq GF \leq 1$.

A Gradient Factor of 0 represents the ambient pressure line.

A Gradient Factor of 1 represents the M-value line.

Gradient Factors modify the original M-value equations for conservatism within the decompression zone.

The lower Gradient Factor value (GF Lo) determines the depth of the first stop. Used to generate deep stops to the depth of the "deepest possible deco stop."

Graph from Erik Baker's "Clearing Up The Confusion About Deep Stops"

Menu Reference

Turn Off

The “Turn Off” item puts the computer to sleep. While sleeping, the screen is blank, but the tissue contents are maintained for repetitive diving. The “Turn Off” menu item will not appear during a dive on any model. It will also not appear after a dive until the End Dive Delay Time has expired to allow for a continuation dive.



Calibration

The Calibrate menu is only available on the Petrel EXT model. It will only appear when in CC mode with the PPO2 mode set to Ext. This menu calibrates the mV output from the oxygen sensors to PPO2.

Upon selecting the calibration menu, the screen will show:

- Top row: Millivolt (mV) readings from the 3 O2 sensors.
- Middle row: PPO2 values (using the previous calibration).
- Bottom row: The calibration gas fraction of O2 (FO2).

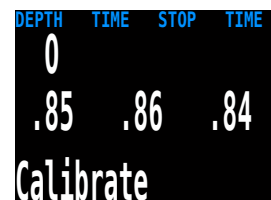

If you need to change the calibration gas FO2, do this in the System Setup → O2 Setup menu.

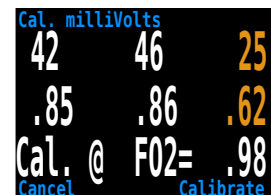

After flooding the breathing loop with the calibration gas (typically pure oxygen), press the SELECT button to perform the calibration.

Good sensors should be in the range of 35 - 65 mV at sea level in 100% oxygen, so a sensor will fail calibration if not in the range of 30mV to 70 mV. This allowable range scales automatically with changes to FO2 and barometric pressure. A millivolt reading is shown in **yellow** if outside the allowable range.

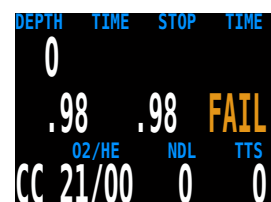

Once the calibration completes, a report will be shown. This shows which sensors passed calibration, and the value of the expected PPO2 based on barometric pressure and the FO2.

Back at the main screen, the displays should now all read the expected PPO2. For example, if FO2 is 0.98 and barometric pressure is 1013 mbar (1 ata), then PPO2 will be 0.98. If any display shows **FAIL**, the calibration has failed because the mV reading is out of range.

The “Calibrate” menu item will not display during a dive.

Single Sensor Mode

A single external O2 sensor may be used.

To enter this mode, perform the calibration with only the middle sensor connected.

The Petrel will see that only one sensor is connected, and automatically switch to single sensor mode.

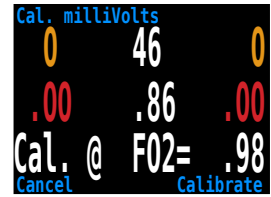

Calibration Problems

One sensor displays FAIL after calibration

This could indicate a bad sensor. It has failed because the mV output was not in range. The sensor could be old or damaged, and should be inspected. Damage and corrosion to wires or connectors is also a common problem. Fix the problem and recalibrate before diving.



All sensors display FAIL after calibration

This could be caused by an accidentally unplugged cable or a damaged cable or connector. Also, accidentally performing the calibration in air or without a proper oxygen flush could cause this problem. A failed calibration can only be fixed by performing a successful calibration.



PPO2 does not show 0.98 after calibration

If you use a calibration FO2 setting of 0.98 and are at sea level, you probably expect the calibrated PPO2 to show 0.98. Sometimes you might correctly get a different value like 0.96 or 1.01.

This is because weather causes minor changes in barometric pressure. For example, say a low-pressure weather system has reduced the normal (1013mbar) barometric pressure to 990mbar. The PPO2 in absolute atmospheres is then $0.98 * (990/1013) = 0.96$.

The 0.96 PPO2 result is, in this case, correct. At high altitudes, the difference between FO2 and PPO2 will be even larger. To see the current pressure, start at the main screen and press the SELECT button a few times (displays as Pressure mBar NOW).

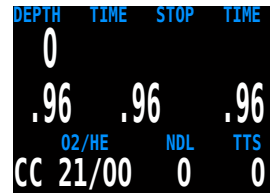

Switch Setpoint

This menu is only available in CC mode when PPO2 mode is set to Int. (internal).

The internal PPO2 mode is used to calculate decompression for a unconnected rebreather. In this case, the setpoints are switched in the computer to approximate the rebreather setpoint.

During a dive the “Switch Setpoint” menu item will be the first item displayed, since the “Turn Off” and “Calibrate” displays are disabled when diving.

Pressing SELECT when this menu is displayed changes the PPO2 setpoint from the low setpoint to the high setpoint or vice-versa. To redefine the PPO2 value of a setpoint, use the Dive Setup menu.

This menu item performs a manual switching of PPO2 setpoint. In the System Setup → Auto SP Switch menu, the Petrel can be setup to automatically perform setpoint switches at programmable depths. When auto setpoint switches are enabled, this menu item is still available to provide manual control.



Select Gas

This menu item allows you to pick a gas from the gases you have created. The selected gas will be used either as the breathing gas in open circuit mode, or the diluent in closed circuit mode.

Gases are always sorted from most to least oxygen content.

Use the MENU button to increment to the desired diluent/gas, then press the SELECT button to select that diluent/gas.

If you increment past the number of gases available, the display will fall back out of the “Select Gas” display without changing the selected gas.

An ‘A’ will appear next to the currently active gas.

A gas that is off will be shown in **magenta**, but can still be selected. It will be turned on automatically if it is selected. Off gases are not used in decompression calculations.

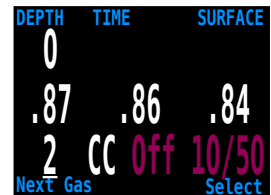
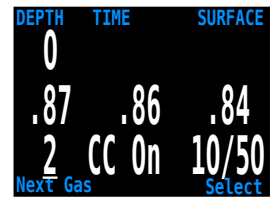
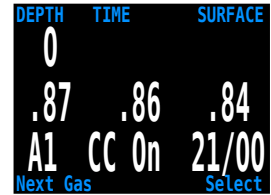
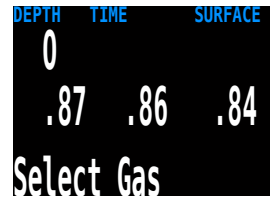

Radio Station Gases



For computer models that support open circuit and closed circuit operation, the system maintains two sets of gases - one for open circuit and one for closed circuit.

The way they operate is very similar to the way car radios work with AM and FM stations.

When you are listening to an FM station and you push a station selection button, it will take you to another FM station. If you add a new station, it will be an FM station.

Similarly, if you are in the AM mode, adding or deleting a station would add or delete an AM station.

With radio station gases, when you are in open circuit, adding, deleting or selecting a gas will refer to an open circuit gas. Just like the FM stations are selected when your radio is in FM mode, the closed circuit gases are available in the closed circuit mode. When you switch to open circuit, the gases available will be open circuit gases.

Select Gas Menu Styles

Two styles of Select Gas menus are available, **Classic** and **New**.

Change between the two styles in the Adv. Config 1 menu.

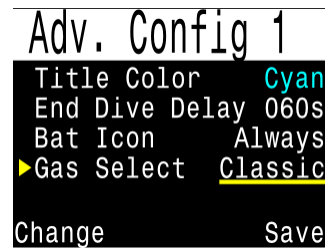

Classic Style Select Gas

The classic Select Gas style is as described on the previous page.

- One gas is shown at a time.
- Press MENU to step through gases, and SELECT to select the shown gas.
- Gases are sorted from highest O2% to lowest O2%.
- Stepping past the last gas will exit the menu without changing the active gas.
- Upon entering the Select Gas menu, the first gas shown is always the highest O2% gas.

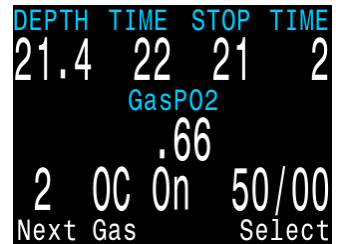

Classic Select Gas

New Style Select Gas

The new style makes visualizing the gas list easier. It also reduces button presses for deco gas switches.

- Shows all gases on the screen at once.
- Press MENU to step through gases, and SELECT to select the pointed to gas.
- A gas must be selected to exit the menu (scrolling past last gas wraps back to first gas).
- The active gas is shown with a white background.
- Turned off gases are shown in **magenta** (purple).
- Gases are sorted from highest O2% to lowest O2%.
- When diving and there is a deco stop, the first gas pointed to will be the most appropriate gas (highest PPO2 less than 1.61). This reduces button presses in most cases.
- On the surface or when no deco stops are needed, the first gas pointed to will be the active gas.

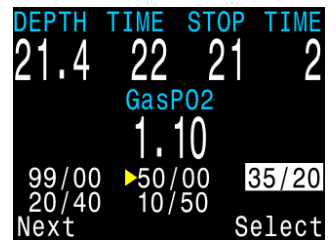

New Style Select Gas

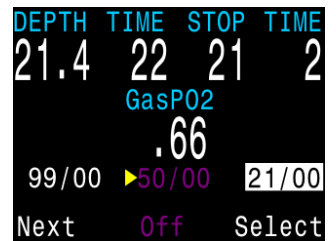

Off Gases are Magenta

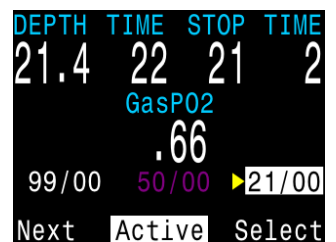

Active Gas is White

Switch to OC/CC

Depending on the current computer setting, this selection will show as either “Switch CC > OC” or “Switch OC > CC”.

Pressing SELECT will select the displayed mode for decompression calculations. When switching to open circuit while diving, the most appropriate open circuit gas will become the breathing gas for calculations.

At this point, the diver may want to switch to a different gas, but since the diver may have other things to deal with, the computer will make a “best guess” of which gas the diver would choose.

On computers with external oxygen sensor monitoring, there is also an option to set the computer to calculate decompression predictions using semi-closed circuit. This is enabled in the System Setup menu.

You can also switch to from CC to OC on a fixed PPO2 model. In that case, the computer will use the user entered high and low setpoints.

Dive Setup+

The Dive Setup menus are available both on the surface and when diving.

The values in Dive Setup+ can also be accessed in the Systems Setup+ menu, but the System Setup+ menu is not available when diving.

Pressing SELECT will enter the Dive Setup sub-menu.

Low Setpoint

This item allows you to set the low setpoint value. It will display the currently selected value. Values from 0.4 to 1.5 are allowed. A press of MENU will increment the setpoint.

Press the SELECT button when “Edit Low SP” is displayed and the edit display will be shown. It is set at the lowest valid value for setpoint, .4.

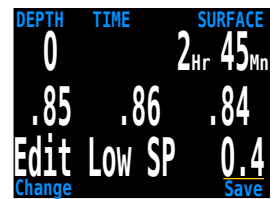
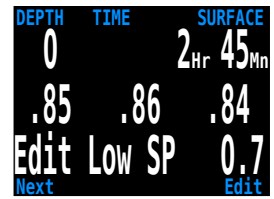
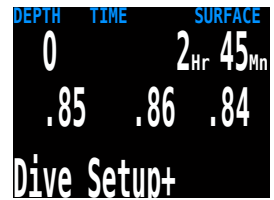
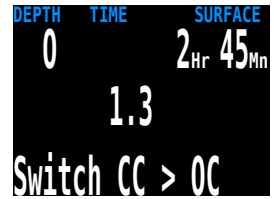
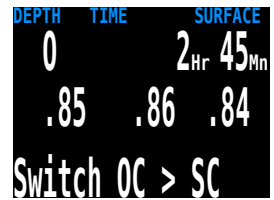
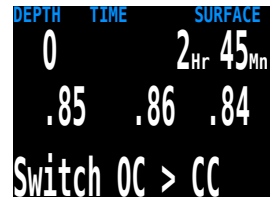
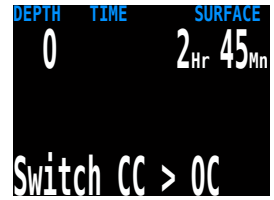

Another press of MENU will increment it again.

DEPTH 0 TIME 2 Hr 45 Mn SURFACE .84
.85 .86 .84
Edit Low SP 0.5
Change Save

If SELECT is pushed, the currently displayed setpoint will be selected, and the display will return to the “Edit Low SP” menu item.

DEPTH 0 TIME 2 Hr 45 Mn SURFACE 1.5
.85 .86 .84
Edit Low SP
Next Edit

If the highest allowable value, 1.5, has been passed, the value will return to 0.4.

High Setpoint

The high setpoint function works exactly like the low setpoint function.

DEPTH 0 TIME 2 Hr 45 Mn SURFACE 1.3
.85 .86 .84
Edit High SP
Next Edit

Define Gas

The function allows you to set up 5 gases in Closed Circuit and 5 gases in Open Circuit. You must be in Open Circuit to edit open circuit gases, and you must be in Closed Circuit to edit closed circuit diluents. For each gas, you can select the percentage of oxygen and helium in the gas. The remainder is assumed to be nitrogen.



Pushing SELECT when “Define Gas” is displayed presents the function to define gas number 1.

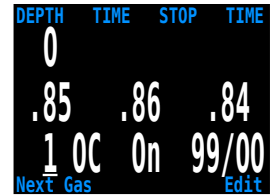

Pushing the MENU button will display the next gas.

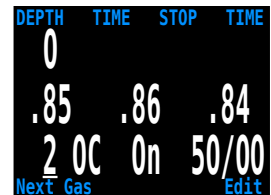

Pushing SELECT will allow you to edit the current gas. The gas contents are edited one digit at a time. The underline will show you the digit being edited.

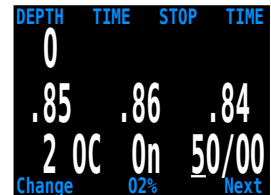

Each push of the MENU button will increment the digit being edited. When the digit reaches 9, it will roll over to 0.

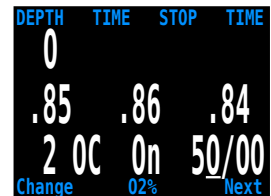

Pushing SELECT will lock in the current digit, and move on to the next digit.

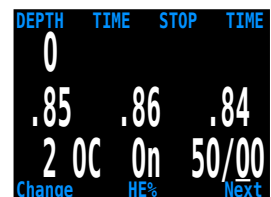

Pushing SELECT on the last digit will finish editing that gas, and bring you back to the gas number.

Any gases that have both oxygen and helium set to 00 will not be displayed in the “Select Gas” function.



Shearwater Petrel SA & EXT

Pushing MENU will continue to increment the gas number.

DEPTH	TIME	STOP	TIME
0			
.85	.86	.84	
2 OC	On	50/00	
Change	HE%	Save	

Note: The “A” denotes the active gas. You cannot delete the active gas. If you try, it will generate an error. You can edit it, but cannot set both the O2 and HE to 00.

The computer will display all 5 gas entries available to allow you to enter new gases.

DEPTH	TIME	STOP	TIME
0			
.85	.86	.84	
A3 OC	On	14/55	
Next Gas		Edit	

Pressing MENU one more time when the fifth gas is displayed will return you to the “Define Gas” menu item.

DEPTH	TIME	STOP	TIME
0			
.85	.86	.84	
5 OC	On	00/00	
Done		Edit	



Only turn-on gases you are carrying

Only turn on the gases you are actually carrying on the dive. With radio station gases, the computer has a full picture of the OC and CC gases you are carrying and can make informed predictions about decompression times. There is no need to turn gases off and on when you switch from CC to OC, because the computer already knows what the gas sets are. You should have the CC and OC gases you are actually carrying turned on.

If you often use other gases, but not on this dive, you can enter the gas and turn it off. You can turn gases on and off during a dive and you can also add or remove a gas during the dive if needed.

Dive Planner+

INTRODUCTION

- Calculates decompression profiles for simple dives.
- In closed-circuit (CC) mode, also calculates open-circuit (OC) bail-out (BO).

SETUP

Uses the current gases programmed into the Petrel, as well as the current GF low/high settings. VPM-B dive planning is available on units with the optional VPM-B unlock. Deco profile is computed for the current circuit mode (CC or OC).

ON THE SURFACE

Enter the dive bottom depth, bottom time, respiratory minute volume(RMV) and PPO2 (closed-circuit only).

Note: Residual tissue loading (and CNS%) from recent dives will be used in calculating the profile.

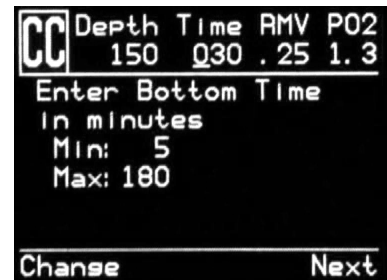

Dive Plan Setup

DURING A DIVE

Computes the decompression profile assuming the ascent will begin immediately. There are no settings to enter. (RMV is last used value)

LIMITATIONS

The Petrel Dive Planner is intended for simple dives. Multi-level dives are not supported.

The Petrel Dive Planner makes the following assumptions:

- Descent rate is 60ft/min (18m/min) and the ascent rate is 33ft/min (10m/min).
- For OC, the gas in use will be the gas with the highest PPO2 less than 1.40 for the bottom gas, and 1.61 for deco gases (the deco gas max PPO2 can be changed in the Adv Config 1 menu).
- For CC, the gas in use will be the gas with the highest PPO2 less than 1.05.
- The planner will use the configured last stop depth.
- For CC, the PPO2 is constant for the entire dive.
- The RMV is the same while diving as during deco.
- Semi-closed uses a metabolic offset.

Shearwater Petrel SA & EXT

The Dive Planner does not provide thorough validation of the profile. For example, it does not check for nitrogen narcosis limitations, gas usage limitations, CNS percentage violations, or isobaric counter-diffusion risks due to sudden helium switches. The user is responsible for ensuring a safe profile is followed.

RESULT SCREENS

The results are given in tables showing:

- Stp: Stop Depth In feet (or meters)
- Tme: Stop Time In minutes
- Run: Run Time In minutes
- Qty: Gas Quantity in CuFt (or liters). OC and BO only

The first two rows are special, the first row showing the bottom time and the second showing the ascent to the first stop. When diving, these two rows are not displayed.

CC	Depth	Time	RMV	P02
	150	030	.55	1.3
Stp	Tme	Run	Gas	
150	bot	30	10/50	
70	asc	32	10/50	
70	1	33	10/50	
60	2	35	10/50	
50	1	36	10/50	
Quit				Next

BO	Depth	Time	RMV	P02
	150	030	.55	1.3
Stp	Tme	Run	Gas	Qty
30	5	43	36/00	6
20	6	49	99/00	6
10	11	60	99/00	8
Quit				Next

Example Results Table for Closed-Circuit and Bailout.

If more than 5 stops are needed, the results will be split onto on several screens. Use the right button to step through the screens.

For OC or BO profiles, a total gas consumption report is given.

BO	Depth	Time	RMV	P02
	150	030	.55	1.3
Gas Usage.	In	CuFt		
99/00:	14			
36/00:	14			
21/25:	7			
12/50:	0			
Quit				Next

Gas Usage Report

Shearwater Petrel SA & EXT

The final result screen shows the total dive time, the time spent on deco and final CNS%.

```
CC Depth Time RMV P02
    150 030 .55 1.3
CC Summary
Run: 61 minutes
Deco: 31 minutes
CNS: 34 %
Quit Plan B0
```

Results Summary Screen

If no decompression is required, no table will be shown. Instead, the total No-Decompression-Limit (NDL) time in minutes, at the given bottom depth will be reported. Also, the gas quantity required to surface (bailout in CC) will be reported.

```
CC Depth Time RMV P02
    080 030 .65 1.3
No Deco Stops.
Total NDL at 80ft
is 47 minutes.
Bailout gas quantity
is 4 CuFt.
Quit Done
```

No Decompression Results Screen

Conservatism

The conservatism settings (GF High and GF Low) can be edited in the Dive Setup menu. While diving, only the GH High value can be edited. This allows changing the surfacing conservatism during a dive. For example, if you worked much harder on the bottom segment than expected, you may wish to add conservatism by reducing the GF High setting

```
DEPTH TIME STOP TIME
0
.85 .86 .84
Conserv 30/70
Next Edit
```

NDL Display

The NDL Display option allows you to display four different values during the dive. The display can be changed during the dive to provide different information.

Pushing SELECT will make the NDL display editable. The first choice available will be **NDL**. If you select NDL, the NDL will always be displayed during the dive whether or not you have a decompression ceiling.

The next selection is **CEIL**. With this setting, as long as the NDL time is 0 (you have a decompression ceiling), the raw ceiling will be displayed instead of the NDL. This is the equivalent of the 'Man on a rope'. It will show your ceiling without it being rounded up to the next even 10 foot or 3 meter stop. Please note that there is very limited information on the effects of following a continuous ceiling instead of stopping at stops and only moving up to the next stop when the stop has cleared.

It is the author's opinion that all stops should be honored. It seems intuitive that if you have bubbles, and you stop, you give the bubbles an opportunity to be resorbed. If you continuously ascend, the ambient pressure is continuously reduced which prevents bubbles from shrinking. Because of this belief, the computer will give one **MISSED DECO STOP** message during the dive and one after the dive, and will flash the stop depth and time in **red** as long as you are above the stop depth. It will use the increased gradient though, and your calculated off-gassing will be faster than staying at the stops.

The next option is to display the actual supersaturation gradient for a pure Bühlmann (99/99) profile.

The selection is **GF99**. With this setting, as long as the NDL time is 0 (you have a decompression ceiling), the gradient will be displayed instead of the NDL.

The number shown is the percentage of supersaturation. The number is calculated by reference to the Ambient Pressure Line and the M-Value line. It can be thought of as the current GF, but it is different in a couple of ways. First, the current GF generates stops rounded to the nearest 10 feet or 3 meters. So a gradient of 40 may reflect a ceiling of 15 feet, but the computer will show a rounded-up 20 foot stop.

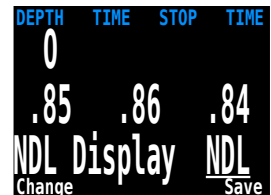

Shearwater Petrel SA & EXT

This number can be used in several ways. First, it can be used to calculate an aggressive ascent that still has some justification in decompression science. For example, if a diver were to lose a significant portion of their gas and needed to get shallow fast, they could ascend until they reached a gradient of 90, then stop until it dropped to 80, then ascend to 90 again, etc. That would produce a Bühlmann-like profile with very little conservatism. In an emergency, that may be an acceptable risk.

Another use might be to do a slower ascent on a dive to sightsee, but to stay in the decompression zone by keeping the gradient above 0.

Another use would be to observe the rapidly increasing gradient in the last 10 feet to the surface and slow that ascent.

All of this is based on gradient theory that may be completely false. There is significant disagreement in the decompression research community about the nature and practice of decompression. Any techniques described here should be considered experimental, but the concepts may be useful to the advanced diver.

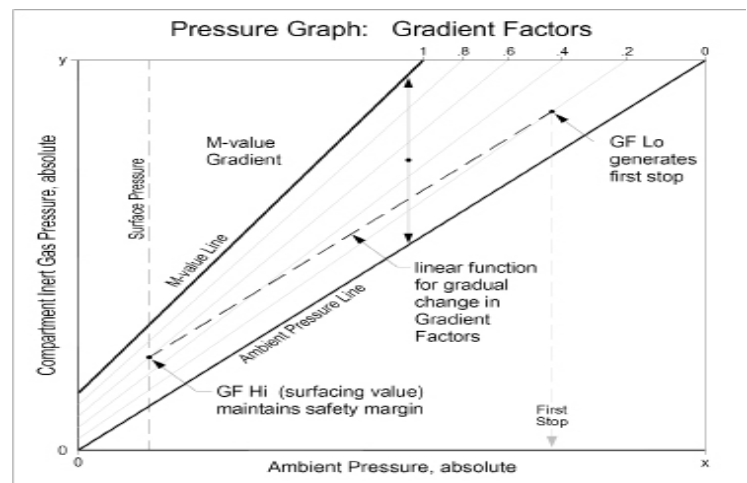

The last selection is **@+5**. This feature was inspired by Dan Wible's CCR2000 computer (Thanks Dan!) It is the time-to-surface (TTS) if you were to stay at the current depth for five more minutes. This can be used as a measure of how much you are on-gassing or off-gassing.

DEPTH	TIME	STOP	TIME
0			
.85	.86	.84	
NDL	Display	@+5	
Change		Save	

For example, on a dive on a wreck, you go to the bottom until you accumulate the desired decompression and TTS. After ascending to the second deck, you notice that the **@+5** and TTS are the same. That means that you can spend 5 minutes exploring this deck without incurring more decompression.

Once you get to the top deck, the current has picked up. The line runs from the top of the deck to the surface which is a distance of 30 feet/10 m. You see that your **@+5** is 11 minutes and your TTS is 15 minutes. That means that you can stay down out of the current for 5 minutes and burn off about 4 minutes of deco. You may decide to accept the 80% decompression efficiency and stay out of the current.

When your TTS is 10 minutes, you see that your **@+5** is 9 minutes. Since the decompression is not very efficient now, you go up the line and spend the last 10 minutes in the current.

External PPO2 Monitoring

The next menu item is used to turn external PPO2 monitoring on and off. By default, external monitoring is turned off and reads “Int.” for Internal fixed setpoint mode. This setting can be changed to “Ext.” to enable external PPO2 monitoring from oxygen sensors.

Now the PPO2 of the three sensors is displayed. A valid calibration must have been previously performed (see the Calibration section).

This system is plugged into three sensors and using the PPO2 input from the sensors as the system average PPO2 used for decompression calculations and CNS tracking.

A voting algorithm is used to decide which of the three sensors are likely to be correct. If a sensor matches either of the other two sensors within $\pm 20\%$, it passes voting. The system average PPO2 is the average of all sensors that have passed voting.

For example, here sensor 3 has failed voting. The PPO2 is displayed in **yellow** to show that it has failed voting. The system average PPO2 is the average PPO2 of sensor 1 and 2.

If all sensors fail voting, then the display will alternate **VOTING FAILED** with the PPO2 measurements (which will all be **yellow** to indicate that voting has failed). When voting has failed, the lowest PPO2 reading will be used for deco calculations (i.e. the most conservative value).

Switching to Open Circuit bailout with External PPO2 Monitoring

If you bailout to OC mode, the external PPO2 will continue to display on the main screen. However, the system PPO2 used for deco calculations will change to OC mode (i.e. PPO2 is the fraction of O2 multiplied by the current depth's pressure).

The external PPO2 continues to display because the diver may need to return to the loop, and will need to know the PPO2 status of the loop, even though the sensor input is not being used as the system PPO2.



Shearwater Petrel SA & EXT

If we now unplug sensor 1 and sensor 3, the computer will use voting logic to pick the two sensors that agree and will think the PPO2 is 0. Sensor 2 will be voted out and flashing yellow. This is a limitation of voting logic, and the user will have to determine which sensors are correct.



With sensors one and three unplugged, we simulate the situation of single sensor monitoring. If we calibrate in this situation, the system will assume that this computer is only attached to one sensor, and will re-configure for fourth sensor monitoring.



It will no longer average the sensors or vote on them. Now the single sensor is the only one considered and the PPO2 used for calculations is the PPO2 of the single sensor.

Brightness

The display brightness has three fixed brightness settings plus an Auto mode.

The fixed options are:

- Low: Longest battery life.
- Med: Best mix of battery life and readability.
- High: Easiest readability, especially in bright sunlight.



Auto will use the light sensor to determine the brightness of the display. The more ambient light there is, the brighter the display will get. At depth, or in dark water, very little brightness is needed to see the display.

The Auto setting works well in most situations.

The brightness of the display is the major determinant of battery life. Up to 80% of the power consumption is to power the display. When a low battery alert occurs, the display brightness is automatically reduced to extend battery life.

Dive Log Menu

Display Log

At the “Display Log” prompt, press SELECT to view the most recent dive.

The profile of the dive is plotted in blue, with decompression stops plotted in red. The following information is displayed:

- Maximum and Average depth
- Dive number
- Date (mm/dd/yy)
- Start- Start of dive
- End- End of dive
- Length of dive in minutes

Press MENU to see the next dive, or SELECT to quit viewing logs.

Press Back to see the list of dive logs, and next to select the next dive and View.

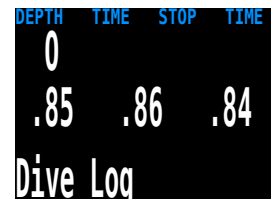

Upload Log

See “Firmware Upload and Dive Log Download” instructions.

Logs are uploaded using Bluetooth. Selecting this menu item starts the Bluetooth connection and then waits for commands from a desktop or laptop computer.

Edit Log Number

The dive log number can be edited. This is useful if you want the Petrel log numbers to match your lifetime dive count.

At the “Edit Log Number” prompt, press SELECT to begin editing. While editing, use MENU to change the value of the currently underlined digit, and SELECT to move to the next digit.

The next dive number will be +1 from the value entered here. For example, if you enter 0015, then the next dive will be dive number 16.

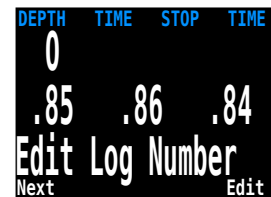

System Setup+

System Setup contains configuration settings together in a convenient format for updating the configuration before a dive.

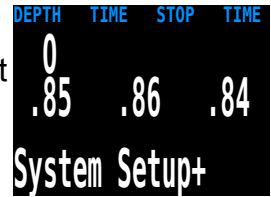

System setup cannot be accessed during a dive.

However, many of the settings are also available during the dive in a single line interface. Although all of the settings available in Dive Setup are available in System Setup, not all settings in System Setup can be edited in Dive Setup.

The MENU and SELECT buttons are context sensitive to each sub menu and individual setting.

When cycling through the sub-menus, MENU will carry the user to the next sub-menu, while SELECT will allow the user to edit the options in this submenu.

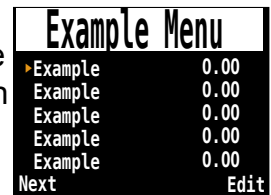

Once the user has pressed SELECT to edit a submenu, MENU will cycle the user through the different submenu listings, while SELECT will let the user edit those listings.

Once the user has pressed SELECT to edit a submenu listing MENU will be used to change the context sensitive variable, while the SELECT button will be used to move to the next field. Once the user has pressed SELECT through all the fields, the new user preferences will be saved.

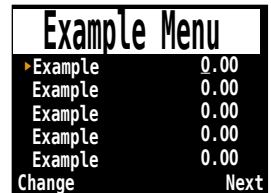

Dive Setup

The first submenu of System Setup+ is Dive Setup.

Mode

Mode sets which breathing circuit configurations are available:

- OC/CC (default)
- OC
- OC/SC (only on models with external PPO2 connector).
- Gauge (e.g. bottom timer mode)

Dive Setup	
Mode	OC/CC
Salinity	Salt
PPO2 Mode	Int
Low SP	0.7
High SP	1.3
Next	Edit



Important information for OPEN CIRCUIT divers

All Petrel models include Closed Circuit (CC) functionality.

Leaving CC mode enabled makes the Petrel more complex and less optimized for OC diving.

Switch Mode from OC/CC to OC before performing an open circuit only dive.

Also, when CC mode is available, then OC is treated as bailout. This is why OC is shown as a yellow warning when CC mode is available.

When changing to or from Gauge mode, the decompression tissues are cleared. This is because when in Gauge mode the Petrel does not know what gas you are breathing.

Salinity

Water type (salinity) affects how the measured pressure is converted to depth. Settings:

- Fresh
- EN13319
- Salt

Fresh and Salt water differ by about 3%. Salt water, being denser, will display a shallower depth for the same measured pressure versus the Fresh water setting.

The EN13319 value is between Fresh and Salt. It is from the European CE standard for dive computers, and is the Petrel's default value.

PPO2 Mode

PPO2 mode is only set when CC is enabled.

On the Petrel Standalone (SA) model, this value is always Int (internal fixed PPO2).

On the Petrel External (EXT) model, this value can be set to either:

- Int. (Internal fixed PPO2 set points)
- Ext. (External measured PPO2)

The PPO2 Mode can also be changed, even during a dive, in the Dive Setup menu.

When semi-closed circuit (SC) is used, the PPO2 mode must be Ext.

Low and High Setpoints

The Low and High PPO2 Setpoints are only available when CC is enabled and PPO2 Mode is Internal.

Each setpoint can be set from 0.4 to 1.5.

The setpoints can also be edited, even during a dive, in the Dive Setup menu.

Dive Setup	
Mode	OC/CC
Salinity	Salt
PPO2 Mode	Int
Low SP	0.7
High SP	1.3
Next	Edit

Deco Setup

Deco Model

May just show Bühlmann ZHL-16 with gradient factors model, or it may allow you to switch between GF and various types of VPM-B. The choices will be available if you have unlocked VPM-B.

Conservatism

Can be adjusted in either the GF or VPM model.

For a more detailed explanation of their meaning for the GF algorithm, please refer to Erik Baker's excellent articles: *Clearing Up The Confusion About "Deep Stops" and Understanding M-values*. The articles are readily available on the web. VPM-B has conservatism settings from 0 to +5, with higher numbers being more conservative.

Last Stop

Allows you to choose where to do your last stop. The choices are 10ft/3m and 20ft/6m. Note that this setting does not affect decompression. It only makes the TTS prediction more accurate.

NDL Display

These options were previously covered in the Dive Setup+ section.

Deco Setup	
Deco Model	GF
Conserv (GF)	30/70
Last Stop	6m
NDL Display	CEIL
Next	Edit

OC Gases

The next submenu is OC Gases. This menu allows the user to edit the open circuit gases. The options contained here are the same as those in the "Define Gases" subsection of the "Dive Setup" section contained earlier in this manual. The interface conveniently displays all five gases simultaneously.

OC Gases			
1	OC	On	21/00
2	OC	Off	00/00
3	OC	Off	00/00
4	OC	Off	00/00
5	OC	Off	00/00
Next			Edit

For a description of how to appropriately set each gas, please see the above Define Gas section

CC Gases

The next submenu is CC Gases. This menu allows the user to edit the closed circuit diluent gases. The options contained here are the same as those in the "Define Gases" subsection of the "Dive Setup" section contained earlier in this manual. The interface conveniently displays all five gases simultaneously.

CC Gases			
A1	CC	On	21/00
2	CC	Off	00/00
3	CC	Off	00/00
4	CC	Off	00/00
5	CC	Off	00/00
Next			Edit

For a description of how to appropriately set each gas, please see the above Define Gas section

O2 Setup

This menu page is only available in Closed-Circuit (CC) or Semi-Closed (SC) mode when PPO2 mode is set to external (see Dive Setup page).

Cal. FO2

This setting allows you to set the fraction of oxygen (FO2) of the calibration gas.

In CC mode, the calibration gas FO2 can be set from 0.70 to 1.00. The default value of 0.98 is for pure oxygen, but assumes about 2% water vapor due to the diver's breathing on the loop during the flushing process.

In SC mode, the calibration gas FO2 can be set from 0.20 to 1.00. This is because semi-closed divers do not always have oxygen available.

Note: When in SC mode the user cannot utilize internal PPO2 monitoring.

Sensor Disp

Sets the sensor display mode on the center row of the main screen.

In CC mode, the available settings are:

- Large: the PPO2 text is the normal large font.
- Giant: the PPO2 text is larger.

In SC mode, the available settings are:

- PPO2: the PPO2 is shown.
- FiO2: the Fraction of inspired O2 (FiO2) is shown.
- Both: PPO2 shown is large font, FiO2 below in small font.

Auto SP (Setpoint) Switch

This menu page is only available in CC mode when PPO2 mode is set to internal (see Dive Setup page).

Auto Setpoint Switch configuration sets up the setpoint switching. It can be set up to auto switch up only, down only, both, or neither.

First, you set the whether the "Up" switch occurs automatically or manually. If "Up" is set to "Auto", then you can set the depth at which the auto switch occurs.

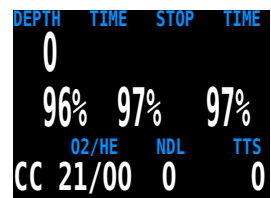
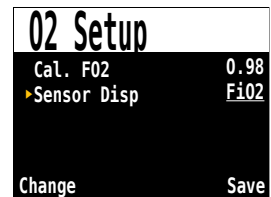
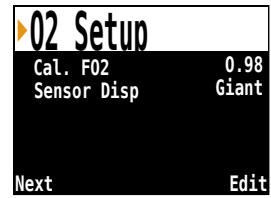

In SC Mode, the center row can show FiO2 instead of PPO2

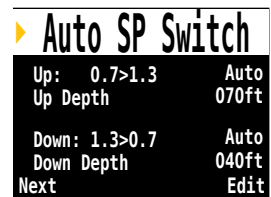

Shearwater Petrel SA & EXT

The menu options are the same for the down setpoint switch.

Example: Up: 0.7>1.3 = Auto, Up Depth = 70 ft.
Down: 1.3>0.7 = Auto, Down Depth = 41ft

The dives starts at the 0.7 setpoint. As you *descend* past 70ft, the setpoint switches “up” to 1.3. You finish your bottom time, then begin ascending. When you *ascend* above 41ft, it switches “down” to 0.7.

When a switch is set to “Auto”, you can always manually override the setting at any time during the dive.

Each auto setpoint switch can occur only once per dive.

Either switch can be set to auto or manual independent of the other switch.

The values 0.7 and 1.3 are shown as examples only. Other values for the low and high setpoint can be adjusted in the Dive Setup menu.

Auto SP Switch	
Up: 0.7>1.3	Auto
▶Up Depth	070ft
Down: 1.3>0.7	Auto
Down Depth	041ft
Change	Next

Auto SP Switch	
Up: 0.7>1.3	Auto
Up Depth	070ft
▶Down: 1.3>0.7	Manual
Change	Save

Display Setup

Units

Two options are available:

- Feet: Imperial units (depth in feet, temperature in °F)
- Meters: Metric units (depth in meters, temperature in °C)

Brightness

Screen brightness can be set to fixed levels or an automatic setting.

Fixed options:

- Low: Longest battery life.
- Med: Best mix of battery life and readability.
- High: Easiest readability, especially in bright sunlight.

The “Auto” option measures ambient light levels and then adjusts the screen brightness to best performance. It provides maximum brightness in bright sunlight, but then lowers brightness to save battery life when the environment gets darker.

Display Setup	
▶Units	Feet
Brightness	Auto
Altitude	SeaLvl
Flip Screen	
Next	Edit

Display Setup	
Units	Feet
▶Brightness	Med
Altitude	SeaLvl
Flip Screen	
Change	Save

Display Setup	
Units	Feet
▶Brightness	Auto
Altitude	SeaLvl
Flip Screen	
Change	Save

Altitude

The altitude setting when set to 'Auto' will compensate for pressure changes when diving at altitude. If all your diving is at sea level, then setting this to 'SeaLvl' will assume that surface pressure is always 1013 mBar (1 atmosphere).



Diving At Altitude

When diving at altitude you must set this option to 'Auto' (the default setting is 'SeaLvl').

Further, when diving at altitude, you **must** turn the computer on at the surface. If the auto-on safety feature is allowed to turn the computer on after a dive has started then the computer assumes the surface pressure is 1013 mBar. If at altitude this could result in incorrect decompression calculations.

Flip Screen

This function displays the contents of the screen upside down. This is used for systems with a permanent connection to a rebreather. It allows the computer to be worn on the right arm.

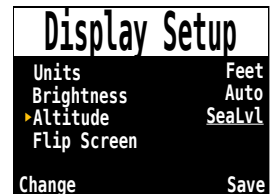
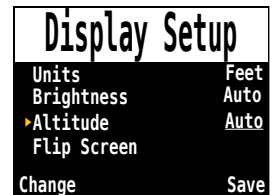

Compass Setup (Petrel 2 only)

Compass View

The Compass View setting can be set to:

- **Off:** The compass is disabled and the Mark Compass option is removed from the menus.
- **60°, 90°, or 120°:** Sets the range of the compass dial that is visible on the main screen. The actual amount of arc that is shown on the screen is 60°, so this may seem the most natural. The 90° or 120° setting can be used to see a wider range.

Compass	
▶ Compass View	90°
Calibrate	
True North	+ 0°
Next	Edit

True North

In most places, a compass does not point towards True North, but rather to Magnetic North. The difference in angle between these two directions is called the magnetic declination (also called magnetic variation), and varies around the world. The declination in your location can be found on maps or by searching online.

Compass	
Compass View	90°
Calibrate	
▶ True North	+ 0°
Next	Edit

This setting can be set from -99° to +99°.

If you only need to match an uncompensated compass, or your navigation is all based on relative directions, then this setting is not necessary and can be left at 0°.

Calibrate

Calibration of the compass may be needed if the accuracy drifts over time or if a permanent magnet or ferromagnetic metal (e.g. iron or nickel) object is mounted very close to the Petrel. To be calibrated out, such an object must be mounted with the Petrel so that it moves along with the Petrel.



Battery Affects the Compass Calibration

Each battery has its own magnetic signature, mostly due to its steel case. Therefore, recalibrating the compass when changing the battery is recommended.

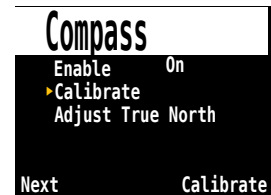

Compare the Petrel with a known good compass or fixed references to determine if calibration is needed. If comparing against fixed references, remember to consider the local deviation between Magnetic North and True North (declination).

Calibration is typically not needed when travelling to different locations. The adjustment needed then is the True North (declination).

When calibrating, rotate the Petrel smoothly through as many 3D twists and turns as possible in 15 seconds. Keep metal and magnetic objects away during calibration. The calibration can also be reset back to the factory values. After calibration, it is recommended to compare the compass accuracy with a known good compass or fixed references



Tips For a Good Compass Calibration

The following tips will help ensure a good calibration.

- Stay away from metal objects. For example, wrist watches, metal desks, boat decks, desktop computers, etc. can all interfere with the Earth's magnetic field.
- Rotate to as many 3D positions as possible. Upside down, sideways, on edge, etc.
- Compare with another compass (not a smartphone, those are terrible) to check your calibration.

System Setup

Date

The first 'System Setup' changeable option is 'Date,' which allows the user to set the current date.

Time

The next 'System Setup' changeable option is 'Time', which allows the user to set the current time. The format can be set to AM, PM or 24 hour time.

Unlock Code

The next 'System Setup' changeable option is 'Unlock', which allows the user to enter in an unlock in order to change models and to set other features.

Load Upgrade

Use this option to load firmware upgrades. This starts a Bluetooth connection and then waits for commands from a laptop or desktop computer.

See the section 'Firmware Upload and Dive Log Download' for detailed instructions.

Reset to Defaults

The final 'System Setup' option is 'Reset to Defaults'. This will reset all user changed options to factory settings and clear the tissues on the Petrel. 'Reset to Defaults' cannot be reversed.

Note: This will not delete dive logs, or reset dive log numbers.

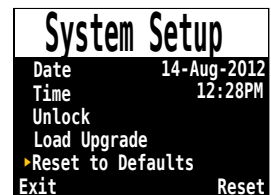
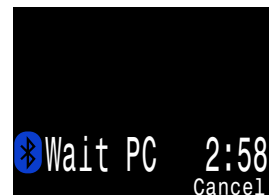
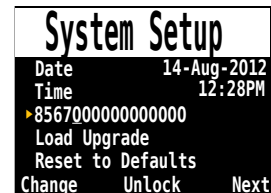
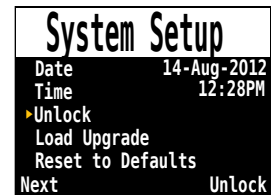
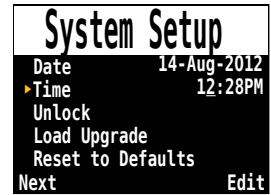
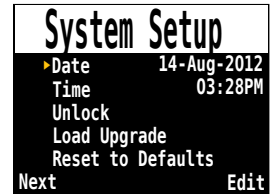

Advanced Configuration 1

Advanced configuration contains items that will be used infrequently and can be ignored by most users. They provide more detailed configurations.

The first screen allows you to enter the advanced configuration area, or to set the advanced configurations settings to their default.

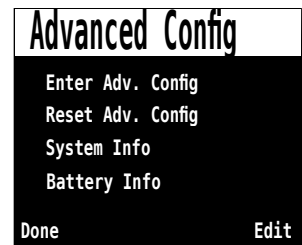

Title Color

The title colors can be changed for added contrast or visual appeal. Default is Cyan, with gray, white and blue also available.

End Dive Delay

Sets the time in seconds to wait after surfacing before ending the current dive.

This value can be set from 20 seconds to 600 seconds (10 minutes). Default is 60s.

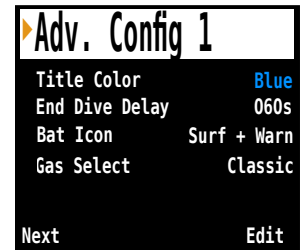

This value can be set to a longer time if you want brief surface intervals connected together into one dive. Some instructors use a longer end dive delay when teaching courses. Alternatively, a shorter time can be used to exit dive mode more quickly upon surfacing.

Battery Icon

The behavior of the battery icon can be changed here. Options are:

Surf+Warn: The battery icon displays always when on the surface. During dive it displays only if there is a low battery warning.

Always: The battery icon always displays.

Warn Only: The battery icon only appears when there is a low battery warning (this is how the Predator operates).

Gas Select

The style of Select Gas menu. Either **Classic** or **New**. Classic style shows one gas at a time in the large font. New style shows all gases at once, but in the small font.

Advanced Configuration 2

This section allows changing of PPO2 limits.

Warning: Do not change these values unless you understand the effect.

All values are in absolute atmospheres [ata] of pressure (1 ata = 1.013 Bar)

▶ Adv. Config 2		
OC Min.	PP02	0.19
OC Max.	PP02	1.65
OC Deco	PP02	1.61
CC Min.	PP02	0.40
CC Max.	PP02	1.60
Done		Edit

OC Min. PPO2

PPO2 displays in flashing red when less than this value. (Default 0.19)

OC Max. PPO2

PPO2 displays in flashing red when greater than this value. (Default 1.65)

OC Deco. PPO2

The decompression predictions (TTS and NDL) will assume that the gas in use at a given depth is the gas with the highest PPO2 that is less than or equal to this value. Also, the suggested gas switches (when the current gas is displayed in yellow) are determined by this value. If you change this value, please understand its effect. For example, if lowered to 1.50, then oxygen (99/00) will not be assumed at 20ft/6m. (Default 1.61)

Note: Semi-closed (SC) PPO2 alarms and gas switch depths use the OC values.

CC Min. PPO2

PPO2 displays in flashing red when less than this value. (Default 0.40)

CC Max. PPO2

PPO2 displays in flashing red when greater than this value. (Default 1.60)

Note: In both OC and CC mode, a “Low PPO2” or “High PPO2” alert is displayed when the limits are violated for more than 30 seconds.

Firmware Upload and Dive Log Download

Bluetooth communications are used for both Firmware Uploading and Dive Log Downloading.

NOTE: Upgrading the firmware resets decompression tissue loading. Plan repetitive dives accordingly.

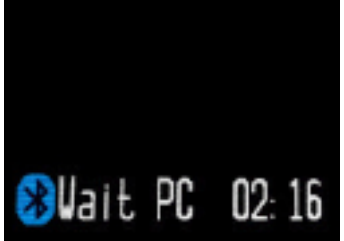
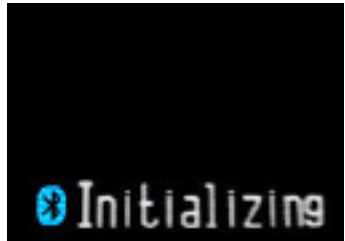
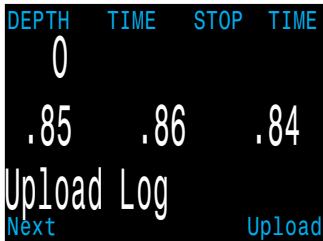

Start a Bluetooth connection by selecting the Upload Log menu. The Petrel screen will switch from "Initializing" to "Wait PC" which will have a countdown.



Now go back to the Shearwater Desktop. Click start from the open "Update Firmware Box", or "Download Log." The PC will then connect to the Petrel, and send the new firmware.



The Petrel screen will give percentile updates of receiving the firmware, then the Personal Computer will read "Firmware successfully sent to the computer".

After receiving the new firmware, the Petrel will reset and display a message stating either firmware update success or failure.

Warning: During the update process, the screen may flicker or go blank for a few seconds. Do not remove the battery during the upgrade process.

Changing the Battery

NOTE: A large coin or washer is required for this section.

Turn off the Petrel

It is a good practice to turn off the Petrel before removing the battery. If removed while on, then there is a small chance (about 1 in 5000) that the deco tissues will be corrupted. The Petrel detects this using a cyclic redundancy check (CRC), so there is no danger. However, the tissues will be lost and repetitive dives will need to be planned accordingly.

Remove the battery cap

Insert the coin or washer into the battery cap slot. Unscrew by turning counter clockwise until the battery cap is free. Be sure to store the battery cap in a clean dry space.

Exchange the battery

Remove the existing battery by tilting the Petrel computer. Insert the new battery positive contact first. A small diagram on the bottom of the Petrel shows the proper orientation.

Accepted battery types

The Shearwater Petrel can accept a wide variety of AA sized batteries. The Petrel can accept any AA sized (or 14500 size) battery that outputs a voltage between 0.9V and 4.3V.

Reinstalling the battery cap

It is very important that the battery cap O-ring is clear of dust or debris. Carefully inspect your O-ring for any debris or damage and gently clean. It is recommended that you lubricate your battery cap's O-ring on a regular basis with an O-ring lubricant compatible with Buna-N (Nitrile) O-rings. Lubricating helps ensure that the O-ring seats properly and does not twist or bunch.

Insert the battery cap into the Petrel and compress the battery contact springs. While the springs are compressed rotate the battery cap clockwise to engage the threads. Be sure not to cross thread the battery cap's threads. Tighten the battery cap until snug. Do not over tighten the battery cap.



Battery Types

After changing the battery, a screen will prompt for the battery type to be entered.

The Petrel attempts to guess what type of battery is being used. If the battery type is incorrect, it should be manually edited.

Having the battery type set correctly is important so that the Petrel can give low battery warnings at the proper voltage levels.

Supported battery types are:

1.5V Alkaline: The common AA battery type that can be purchased at most supermarkets and electronics stores around the world. Not rechargeable. Inexpensive and reliable, they provide 35 hours of operation. Recommended.

1.5V Photo Lithium: Fairly common, but more expensive than alkalines. They provide about 55 hours of operation. Not rechargeable. Good for use in very cold water. Recommended.

1.2V NiMH: Common rechargeable batteries used in digital cameras and photo flashes. Can have high self discharge. Provide about 30 hours of operation per charge. Can die quickly, so care should be taken to ensure sufficient charge prior to diving.

3.6V Saft: The Saft LS14500 lithium batteries provide very high energy density. However, their high cost makes other battery types a better choice for most users. Provide about 100 hours of operation. Can die quickly, so care should be taken to ensure sufficient charge prior to diving.

3.7V Li-Ion: Rechargeable 14500 Li-Ion batteries provide about 35 hours of operation per charge. Can be ordered from the internet. Have more gradual voltage drop as discharged, so easier to determine remaining capacity than NiMH rechargeables. Good in cold water.

NOTE: Battery operating lifetimes are given with screen on medium brightness and at room temperature. Higher brightness and lower temperature can reduce life. Lower brightness can increase life.

Tissues Cleared

Some conditions will cause the decompression inert gas tissue loadings to be cleared. When cleared, the tissues are set to being saturated with breathing air at the current barometric pressure.

The Petrel does not lock-out when the tissues are cleared. If the tissues are cleared, then the diver must take appropriate cautions when planning repetitive dives. The Petrel clearly notifies when tissues are cleared, so that the diver has the proper information to make responsible decisions.

For example, after changing the battery, you will see one of these two screens:

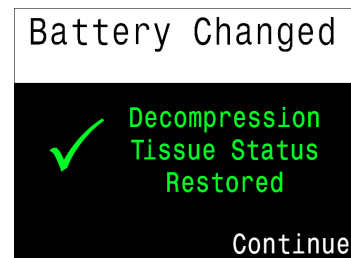
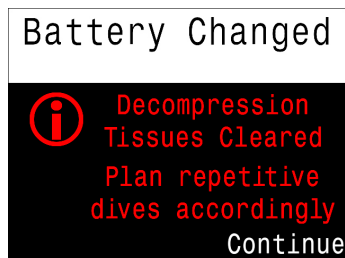

Conditions that cause the tissues to be cleared are:

Firmware Updates: A firmware update will clear the tissues. Therefore, updating the firmware in the middle of a dive trip is not a good idea.

User Request: You can clear the tissues manually in the System Setup → System Setup menu. Use the Reset To Defaults option. This will then prompt if you want to reset the settings only, the tissues only, or both.

Slow Battery Change: Quick battery changes do not normally cause the tissues to be cleared. A super capacitor stores energy to keep the clock running for at least 15 minutes during a battery change. If battery removed for longer than 15 minutes, then the tissues will be cleared.

Corruption: A 32-bit cyclic redundancy check (CRC) is used to verify the integrity of the tissues each time the Petrel is turned on. If corrupted, the tissues will be cleared. The most likely cause of corruption is removing the battery with the Petrel turned on. Therefore, turning the Petrel off before changing the battery is the best practice.

Changing To/From Gauge Mode: In gauge mode the Petrel does not know what gas you are breathing and cannot track tissue loading. Therefore, when changing to or from gauge mode, the tissues are cleared.

Error Displays

The system has several displays that alert an error condition.



Limitations of Alarms

All alarm systems share common weaknesses.

They can alarm when no error condition exists (false positive). Or they can fail to alarm when a real error condition occurs (false negative).

So by all means respond to these alarms if you see them, but NEVER depend on them. Your judgement, education, and experience are your best defenses. Have a plan for failures, build experience slowly, and dive within your experience.

Each of the alarms will display the message in **yellow** until dismissed. The error is dismissed by pressing SELECT.

This message will appear if the average **PPO2** goes **above 1.6** for more than 30 seconds.



This message will appear if the average **PPO2** goes **below 0.4 (.19 for OC or SC)** for more than 30 seconds.

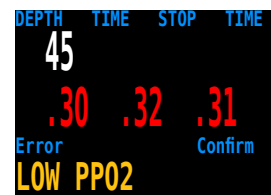

It is not unusual to get this error immediately after submerging with a manual CCR and a hypoxic mix. The first breath after submerging floods the loop with low PPO2 gas. The situation is usually resolved by increasing depth such that when the error is noticed, the PPO2 is no longer low.

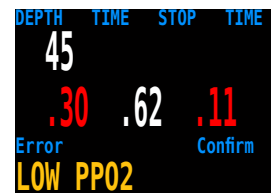

This condition will also cause the “**LOW PPO2**” display to appear. Here, the computer does not have two sensors that have confirming values. There is no way to know the actual PPO2, and the average PPO2 will be calculated as 0.11 (the lowest value is the most conservative for decompression calculations).

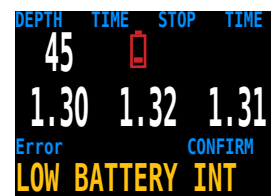

This message will appear when your internal battery is low for 30 seconds. The battery needs to be changed. The computer will also flash the battery symbol **red**.

Shearwater Petrel SA & EXT

This alarm is a notification that there has either been a very fast ascent for a short period of time, or that there has been an ascent of more than 66 fpm / 20 mpm maintained for over a minute. This alarm may return after being dismissed if the condition occurs again.

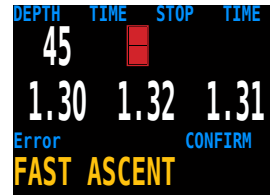

The alarm occurs when the diver has been above the minimum depth for a decompression stop for more than one minute. This alarm will only appear once during a dive, but it will also appear once on the surface after the dive.



This alarm will show when the decompression tissues are cleared. All decompression information has been lost.



This alarm happens when the computer does not complete all of its tasks in the time allotted. It can happen occasionally from a transient problem like a battery bounce after an impact. It can also be the result of a hardware problem.



This reset shows up after a software update. This is the normal event that shows the computer has been rebooted after the software update.

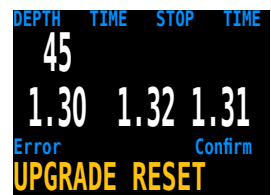

This is not an exhaustive list. Please contact Shearwater if you experience any unexpected errors.

The center row also shows permanent "Low PPO2" or "High PPO2" messages when the PPO2 is not in a safe range. These message will clear automatically once a safe PPO2 is restored.



Sample Errors on Center Row

Storage and Maintenance

The Petrel dive computer should be stored dry and clean.

Do not allow salt deposits to build up on your dive computer. Wash your computer with fresh water to remove salt and other contaminants. **Do not use detergents or other cleaning chemicals** as they may damage the Petrel dive computer. Allow to dry naturally before storing.

Do not wash under high pressure jets of water as it may cause damage to the depth sensor.

Store the Petrel dive computer out of direct sunlight in a cool, dry and dust free environment. Avoid exposure to direct ultra-violet radiation and radiant heat.

Servicing

There are no user serviceable parts inside the Petrel.

Do not tighten or remove the faceplate screws.

Clean with water ONLY. Any solvents may damage the Petrel dive computer.

Service of the Petrel may only be done at Shearwater Research, or by any of our authorized service centers.

Your nearest service center can be found at www.shearwaterresearch.com/contact

Fischer Pin-out

On the EXT model, the Fischer connector pin-out is as shown (looking into socket on Petrel).

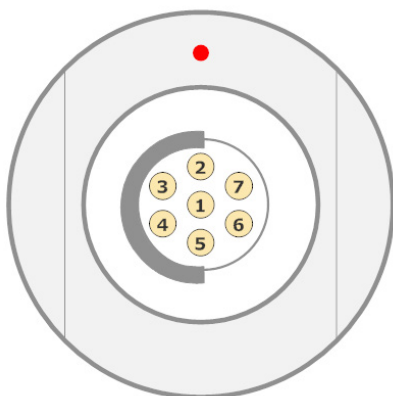

1 = Common - (GND)

2 = O2 Sensor 1+

3 = O2 Sensor 2+

4 = O2 Sensor 3+

Specifications

Specification	Standalone (SA) Model	External PPO2 (EXT) Model
Operating Modes	OC OC/CC (internal PPO2) Gauge	OC OC/CC (internal PPO2) OC/CC (external PPO2) OC/SC (external PPO2) Gauge
Decompression Model	Bühlmann ZHL-16C with GF VPM-B and VPM-B/GFS (optional)	
Pressure (depth) sensor	Piezo-resistive	
Range	0 Bar to 14 Bar	
Accuracy	+/-20 mBar (at surface) +/-100 mBar (at 14bar)	
Crush Depth Limit	30 Bar (~290msw)	
Surface Pressure Range	500 mBar to 1080 mBar	
Depth of dive start	1.6 m of sea water	
Depth of dive end	0.9 m of sea water	
Compass Resolution	1° (Petrel 2 only)	
Compass Accuracy	+/- 5° (Petrel 2 only)	
Operating Temperature Range	+4°C to +32°C	
Short-Term (hours) Temperature Range	-10°C to +50°C	
Long-Term Storage Temperature Range	+5°C to +20°C	
Battery	AA Size, 0.9V to 4.3V	
Battery Operating Life (Display Medium Brightness)	35 Hours (AA 1.5V Alkaline) 100 Hours (SAFT LS14500)	
External Connector Socket	N/A	Fischer 103, 7-pin
External O2 Sensor Type	N/A	"10mV in air" Type: Zero offset Linear response to PPO2 Temp. comp. in sensor Common negative Range 0mV to 100mV
External O2 Sensor Input Resistance	N/A	100kΩ
Weight	0.4kg	
Size (W X L X H)	84mm X 74mm X 38mm	100mm X 74mm X 38mm

FCC Warning

a) USA-Federal Communications Commission (FCC)

This equipment has been tested and found to comply with the limits for a Class B digital device, pursuant to Part 15 of FCC Rules. These limits are designed to provide reasonable protection against harmful interference in a residential installation. This equipment generates, uses, and can radiate radio frequency energy. If not installed and used in accordance with the instructions, it may cause harmful interference to radio communications. However, there is no guarantee that interference will not occur in a particular installation.

If this equipment does cause harmful interference to radio or television reception, which can be determined by tuning the equipment off and on, the user is encouraged to try and correct the interference by one or more of the following measures:

- Reorient or relocate the receiving antenna
- Increase the distance between the equipment and the receiver.
- Connect the equipment to outlet on a circuit different from that to which the receiver is connected.
- Consult the dealer or an experienced radio/TV technician for help.

Any changes or modifications not expressly approved by the party responsible for compliance could void the user's authority to operate the equipment.

Caution: Exposure to Radio Frequency Radiation.

This device must not be co-located or operating in conjunction with any other antenna or transmitter.

Contains TX FCC ID: T7VEBMU

Industry Canada Warning

b) Canada - Industry Canada (IC)

This device complies with RSS 210 of Industry Canada.

Operation is subject to the following two conditions:

- (1) this device may not cause interference, and
- (2) this device must accept any interference, including interference that may cause undesired operation of this device.

L'utilisation de ce dispositif est autorisée seulement aux conditions suivantes :

- (1) il ne doit pas produire d'interférence, et
- (2) l'utilisateur du dispositif doit être prêt à accepter toute interférence radioélectrique reçue, même si celle-ci est susceptible de compromettre le fonctionnement du dispositif.

Caution: Exposure to Radio Frequency Radiation.

The installer of this radio equipment must ensure that the antenna is located or pointed such that it does not emit RF field in excess of Health Canada limits for the general population; consult Safety Code 6, obtainable from Health Canada's website www.hc-sc.gc.ca/ewh-semt/pubs/radiation/radio_guide-lignes_direct-eng.php#sc6

Contains TX IC: 216QEbzzMU