



TERIC



TERIC Operating Instructions



Powerful • Simple • Reliable



Table of Contents

Table of Contents.....	2
Conventions Used in this Manual.....	4
1. Introduction	5
1.1. Notes on this manual.....	6
1.2. Modes Covered by this Manual.....	6
2. Basic Operation	7
2.1. Turning On.....	7
2.2. Buttons.....	8
2.3. Changing between Modes.....	9
2.4. Owner Information Screen.....	9
2.5. Function Button.....	9
3. Dive Mode Interface.....	10
3.1. Default Dive Setup.....	10
3.2. Dive Mode Differentiation.....	10
3.3. Main Screen Layout.....	11
3.4. Detailed Descriptions.....	12
3.5. Info Screens.....	16
3.6. Info Screen Descriptions.....	17
3.7. Home Screen Customization.....	21
3.8. Alerts.....	22
4. Safety and Decompression Stops	24
4.1. Safety Stops.....	24
4.2. Decompression Stops.....	25
5. Decompression and Gradient Factors ...	26
5.1. Decompression Information Accuracy.....	27
6. Example Dives	28
6.1. OC Rec Example Dive.....	28
6.2. OC Tec Example Dive.....	29
6.3. CC Example Dive.....	31
6.4. Gauge Mode.....	34
7. Freedive Mode	35
7.1. Default Freediving Layout.....	35
7.2. Freediving Info Screens.....	36
7.3. Freediving Sets.....	36

8. Dive Tools	39
8.1. Compass.....	39
8.2. Tag Log.....	41
8.3. Reset Average Depth.....	41
8.4. Test Alerts.....	41
8.5. Deco Planner.....	42
8.6. NDL Planner.....	44
9. Air Integration (AI)	45
9.1. What is AI?.....	45
9.2. Basic AI Setup.....	46
9.3. AI Displays.....	49
9.4. Using Multiple Transmitters.....	51
9.5. SAC calculations.....	52
9.6. GTR calculations.....	53
10. Watch Mode	54
10.1. Date And Time.....	54
10.2. Watch Tools.....	54
10.3. Watch Face Colors.....	56
11. Menus	57
11.1. Main Menu.....	57
12. Settings Reference.....	64
12.1. Dive Settings Menu.....	64
12.2. Deco Menu.....	69
12.3. Gases.....	70
12.4. Set Points.....	71
12.5. AI.....	72
12.6. Compass.....	73
12.7. Display.....	74
12.8. Watch.....	76
12.9. General.....	77
13. Firmware Update and Log Download	78
13.1. Shearwater Cloud Desktop.....	78
13.2. Shearwater Cloud Mobile.....	80
14. Teric Strap	81
15. Charging	81
16. Troubleshooting	83



16.1. Warnings and Information Displays.....	83
16.2. AI Connection problems	84
17. Storage and Maintenance	85
17.1. Transmitter Battery Replacement	85
18. Servicing.....	85
19. Glossary	85
20. Teric Specifications.....	86
21. AI Transmitter Specifications	87
22. Regulatory Information.....	87
23. Contact	88



Conventions Used in this Manual

These conventions are used to highlight important information:



INFORMATION

Information boxes contain useful tips for getting the most out of your Teric.



CAUTION

Caution boxes contain important instructions on operating the Teric.



WARNING

Warning boxes contain critical information that may affect your personal safety.



DANGER

This computer is capable of calculating deco stop requirements. These calculations are at best a guess of real physiological decompression requirements. Dives requiring staged decompression are substantially more risky than dives that stay well within no-stop limits.

Diving with rebreathers and/or diving mixed gases and/or performing staged decompression dives and/or diving in overhead environments greatly increases the risk associated with scuba diving.

YOU REALLY ARE RISKING YOUR LIFE WITH THIS ACTIVITY.



WARNING

This computer has bugs. Although we haven't found them all yet, they are there. It is certain that there are things that this computer does that either we didn't think about, or planned for it to do something different. Never risk your life on only one source of information. Use a second computer or tables. If you choose to make riskier dives, obtain the proper training and work up to them slowly to gain experience.

This computer will fail. It is not whether it will fail but when it will fail. Do not depend on it. Always have a plan for how to handle failures. Automatic systems are no substitute for knowledge and training.

No technology will keep you alive. Knowledge, skill, and practiced procedures are your best defense (except for not doing the dive, of course).



1. Introduction

The Shearwater Teric is an advanced dive computer for all types of diving.

Please take the time to read this manual. Your safety may depend on your ability to read and understand the Teric displays.

Diving involves risk and education is your best tool for managing this risk.

Do not use this manual as a substitute for proper dive training and never dive beyond your training. What you don't know can hurt you.

Features

- Vivid full color 1.39" AMOLED display
- Rugged stainless steel bezel and sapphire crystal
- Crush proof to 200m / 650ft
- 5 independently configurable diving modes
- 2 customizable layouts for every dive mode
- 5 customizable gases in every SCUBA mode
- Any combination of Oxygen, Nitrogen and Helium (Air, Nitrox, Trimix)
- Full decompression and CCR Support
- Bühlmann ZHL-16C with gradient factors
- No lockout for violating deco stops
- CNS Tracking
- Quick NDL and full decompression planner built in
- Simultaneous wireless pressure monitoring of 1 or 2 cylinders
- Tilt compensated digital compass with multiple display options
- Dedicated Freedive Mode
- Customizable auditory and vibration alerts
- High-speed depth sampling
- 3 watch faces available in 15 colors
- Bluetooth Dive log uploading to Shearwater Cloud
- Free firmware updates

You **Tube**

Watch the video:
[Teric Introduction](#)



1.1. Notes on this manual

This manual contains cross-references between sections to make it easier to navigate.

Underlined text indicates the presence of a link to another section.

Do not change any settings on your Teric without understanding the consequence of the change. If you are unsure, consult the appropriate section of the manual for reference.

This manual is not a substitute for proper training.



Firmware Version: V16





This manual corresponds to firmware version V16.

Feature changes may have been made since this release and might not be documented here.

Check the release notes on Shearwater.com for a complete list of changes since the last release.

1.2. Modes Covered by this Manual

This manual provides operating instructions for the Teric in Watch Mode as well as five Dive Modes:

- Open Circuit Recreational (OC Rec) 
- Open Circuit Technical (OC Tec) 
- Closed Circuit / Bail Out (CC/BO) 
- Gauge 
- Freedive 

Some features of the Teric only apply to certain dive modes. Look for the corresponding mode icons throughout the manual to help distinguish which features are available in the various modes.

If not otherwise indicated, features described are applicable in all dive modes.

Change the Dive Mode from the Dive Settings menu.
See details on page 64.



2. Basic Operation

2.1. Turning On

To turn the Teric On, press any button.

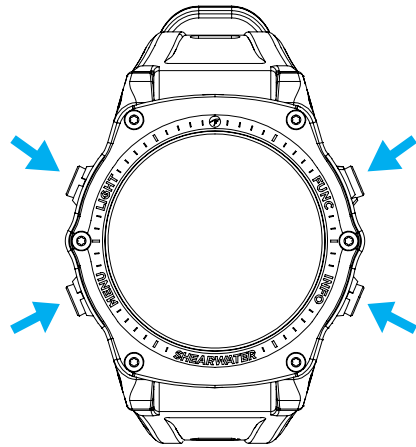

Auto-on

The Teric will automatically turn-on and enter dive mode when submerged underwater. This is based on pressure increase and not on the presence of water. When auto-on is activated, the Teric will enter the last configured dive mode.

Auto-on Details

The Teric turns on automatically and enters dive mode when the absolute pressure is greater than 1100 millibar (mbar).

For reference, normal sea level pressure is 1013 mbar and 1 mbar of pressure corresponds to approximately 1 cm (0.4") of water. So, when at sea level, the Teric will automatically turn-on and enter dive mode when about 0.9 m (3 ft) underwater.

If at higher altitude, then the Teric auto-on will occur at a deeper depth. For example, when at 2000 m (6500 ft) altitude the atmospheric pressure is only about 800 mbar. Therefore, at this altitude the Teric must be submerged underwater by 300 mbar to reach an absolute pressure of 1100 mbar. This means the auto-on occurs at about 3 m (10 ft) underwater when at an altitude of 2000 m.



Do Not Rely On The Auto-On Feature

This feature is supplied as a backup for when you forget to turn on your Teric or forget to place it in dive mode.

Shearwater recommends turning your computer on manually and entering dive mode before each dive to confirm proper operation and to double check battery status and setup.



2.2. Buttons

All Teric operations are simple single button presses.

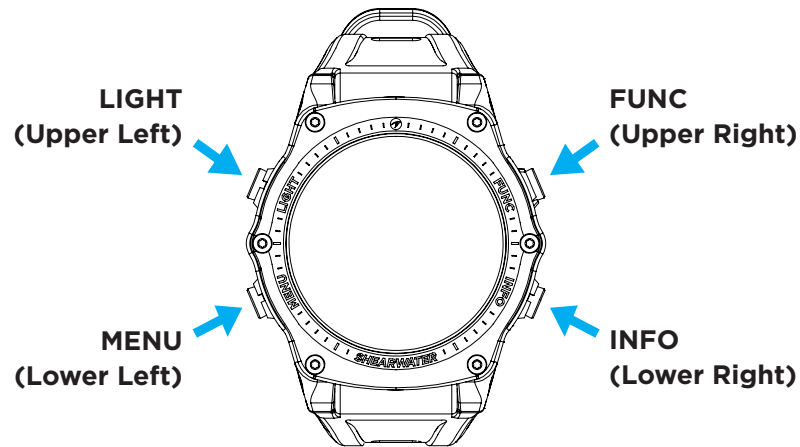

Don't worry about remembering all the button rules below. Button hints make using the Teric easy.

MENU Button (Lower Left)

From the main screen > Brings up the menu
In a menu > Moves down to the next menu item

INFO Button (Lower Right)

From the main screen > Cycles through info screens
In a menu > Exits back to the previous menu or main screen

LIGHT button (Upper Left)

From the main screen > Cycles brightness levels
In a menu > Moves up to the next menu item

FUNCTION Button (Upper Right)

From the main screen > Configurable shortcut
In a menu > Selects menu item

Button Hints

When in a menu, button hints label each button:

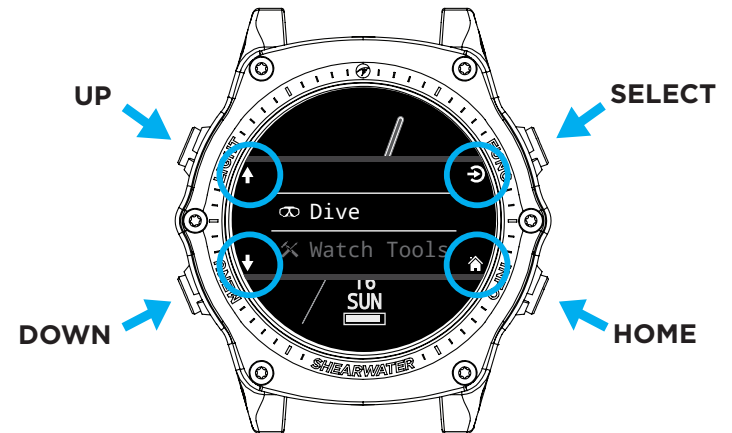

In the example above, the hints tell us:

- Use LIGHT to move up a menu item
- Use MENU to move down a menu item
- Use FUNC to select a menu item
- Use INFO to go back to the home screen

Button Hint Icons:





2.3. Changing between Modes

The two primary modes are Watch Mode and Dive Mode. Watch Mode is only available at the surface.

Switching to Dive Mode



To change from Watch Mode to Dive Mode manually, press the Menu button and select Dive from the main menu.

Dive Mode will automatically be triggered when a dive starts.

[Changing dive modes is covered on page 64.](#)

Switching to Watch Mode

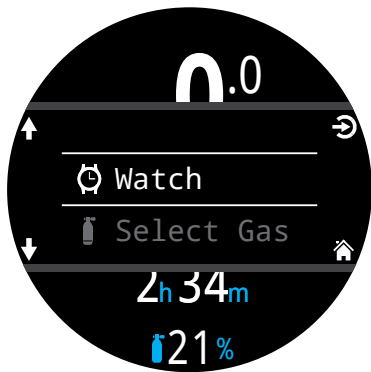

To change from Dive Mode to Watch Mode, press the Menu button and select Watch from the main menu.

The Teric will revert back to Watch Mode after 15 minutes of inactivity on the surface.

2.4. Owner Information Screen



Upon entering Dive Mode, the owner information screen will be displayed for 15 seconds or until any button is pressed.

Owner and contact information can be changed in the [User Info menu \(page 77\)](#).

This display also confirms the current alert notification settings and tests the alerts. Alert notification settings can be changed in the top-level [Alerts menu \(page 67\)](#).

2.5. Function Button

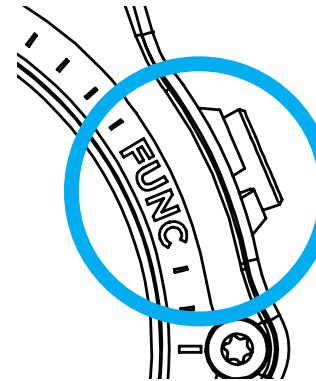

The function (upper right) button is a customizable shortcut that makes accessing your most used functions on the Teric a little easier.

The function button can be customized independently for every mode of operation.

For Watch Mode, the function button can be customized in Settings > Watch.

For each dive mode, the function button can be customized in Settings > Dive.



3. Dive Mode Interface

3.1. Default Dive Setup

The Teric comes pre-configured for recreational diving.

The default dive mode for the Teric is Open Circuit Recreational (OC Rec) displayed with the “Big” screen layout.

As a quick reference, a diagram of the default diving display is shown below.

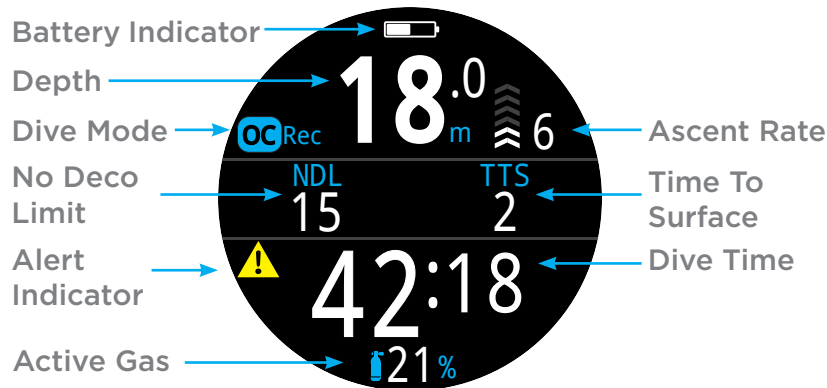

OC Rec mode with Big screen layout

Many attributes of this default mode are shared with the other dive modes. The following sections go into detail about each screen element.

See the [OC Rec Example Dive on page 28](#) for a walk through of how this screen changes through all phases of a dive.

Watch the video:
[User Interface](#)

3.2. Dive Mode Differentiation

Each dive mode is designed to best suit a particular type of diving.

OC Rec

Designed for use during recreational, no-decompression diving activities.

- Nitrox Only - no helium
- Safety Stops
- Enhanced warnings

OC Tec

Designed for use during technical diving activities including planned decompression.

- Full Trimix
- No Safety stops
- TTS permanently on screen in Big layout

CC/BO

Designed for use with a closed circuit rebreather.

- Fast switching from closed circuit to open circuit (BO) operating modes.
- Separate customizable home screens for CC and BO.

Gauge

Gauge Mode turns the Teric into a simple depth and time display (a.k.a. a bottom timer). [See page 34.](#)

- No tissue tracking
- No decompression information

Freedive

Optimized for use while freediving. [See page 35.](#)

- Freediving sets.

[Change the Dive Mode from the Dive Settings menu.](#)
[See details on page 64.](#)



3.3. Main Screen Layout

The Teric has two different screen layouts available in every dive mode, **Big** and **Standard**.

Change the Screen layout from the Dive Settings Menu. See details on page 64.

Big layout

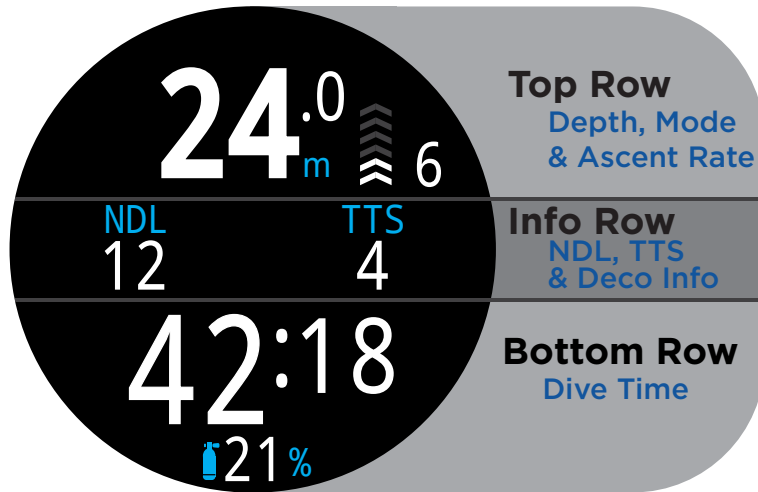

The Big screen layout provides the largest font size at the expense of on screen information.

The top and bottom row contents are reserved for the most critical information and are fixed, while pressing the INFO button scrolls through additional data in the Info row.

In some modes, the right Info row slot can be customized. Read mode about [Home Screen Customization on page 21](#).

The Big screen layout is the default layout for OC Rec, Freedive, and Gauge mode.

Standard layout

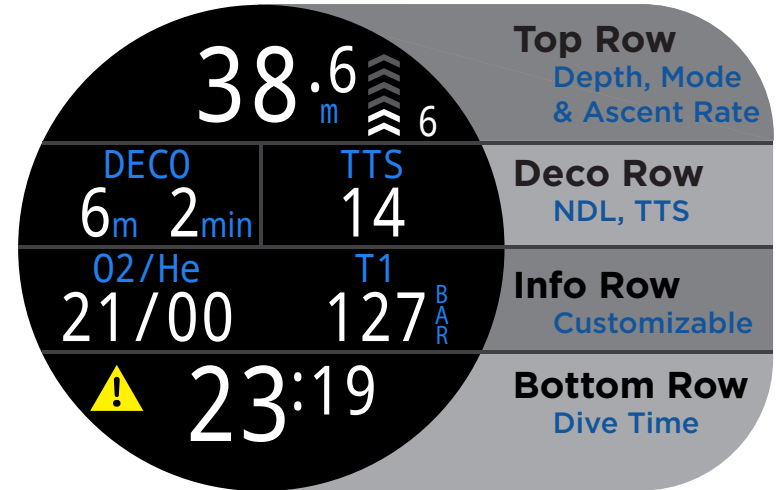

The Standard screen layout has four rows and gives the most information on the screen at the expense of font size.

The Top, Bottom, and Deco row content are reserved for the most critical information and are fixed, while pressing the INFO button scrolls through additional data in the Info row.

The Info row can be customized with up to three pieces of information. Read mode about [Home Screen Customization on page 21](#).

In OC Rec mode, the right Deco Row information slot can also be customized, just like the Info Row.

The Standard screen layout is the default layout for OC Tec and CC/BO.



3.4. Detailed Descriptions

The Top Row

The top row shows depth, ascent rate, battery and mode information.



Depth

Displayed to one decimal place in feet or meters.





Note: If the depth shows a Flashing Red zero or shows at depth at the surface, then the depth sensor needs service.

Ascent Rate Display

Shows how fast you are currently ascending graphically and numerically.

1 arrow per 3 meters per minute (mpm) or 10 feet per minute (fpm) of ascent rate.

-  **WHITE** when less than 9 mpm / 30 fpm (1 to 3 arrows)
-  **YELLOW** when greater than 9 mpm / 30 fpm and less than 18 mpm / 60 fpm (4 or 5 arrows)
-  **FLASHING RED** when greater than 18 mpm / 60 fpm (6 arrows)

Note: Deco calculations assume 10mpm (33fpm) ascent rate.

Freedive Mode Ascent / Descent Rate Display **FD**

Freedivers ascend much faster than SCUBA divers. So, ascent rate in Freedive Mode is measured in feet per second (fps) or meters per second (mps) rather than feet per minute or meters per minute.



In Freedive Mode, 1 arrow per 1 fps / 0.3 mps.



Descent rate is displayed in addition to ascent rate in Freedive Mode.

Read more about [Freedive Mode](#) on page 35.

Battery Icon

The battery icon is shown on the surface but disappears when diving. If low or critical then the battery icon will appear while diving.



WHITE when battery change is OK



YELLOW when battery needs to be charged.



RED when battery must be charged immediately.

Dive Mode Indicator

The dive mode indicator is only shown at the surface (except CC & BO mode).



Open Circuit Recreational (OC REC)



Open Circuit Technical (OC TEC)



Closed Circuit



Bailout (Available in CC/BO mode)



Freedive Mode



Gauge Mode



The Deco Row

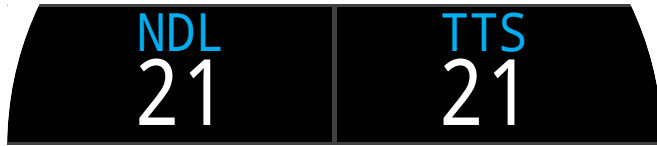

The Deco Row is only shown in the Standard layout, however, the Deco row information described below is shown on the first page of the info row in the Big layout.

No Decompression Limit (NDL)



The time remaining, in minutes, at the current depth until decompression stops will be necessary.



Displays in Yellow when the NDL is less than 5 minutes.

Deco Stop Depth and Time

Once Mandatory decompression is required, NDL will be replaced by decompression information.



The shallowest depth to which you can ascend and how long to hold that stop.

By default the Teric uses a 3m (10ft) last stop depth. At this setting, you may perform the last stop at 6m (20ft) with no penalty. The only difference is that the predicted time-to-surface will be shorter than the actual TTS since off-gassing is occurring slower than expected. There is also an option to set the last stop to 6m (20ft) if you wish.

See the [Decompression Stops section on page 25](#) for details.

Deco Clear Counter



In OC Tec and CC/BO mode, the deco clear counter appears in the DECO box and counts up from zero to show for how long your decompression has been clear.

Safety Stop Counter



In OC Rec mode, the safety stop counter counts down automatically when in the safety stop range. Displays "Clear when the safety stop has completed.



See the [Safety Stops section on page 24](#) for details.

Time-To-Surface (TTS)



The time-to-surface in minutes. This is the current time to ascend to the surface including the ascent plus all required deco stops and safety stops.

The time-to-surface slot can be customized in OC Rec mode. See Page 65 for more details.



Important!

All decompression information including Deco Stops, NDL, and Time to surface are predictions that assume:

- Ascent rate of 10mpm / 33fpm
- Decompression stops will be followed
- All programmed gases will be used as appropriate

Read more about [Decompression and Gradient Factors on page 26](#).



The Info Row

The Info row is the center row in the Big layout and the third row in the Standard layout. Info row information is customizable. See [Home Screen Customization on page 21](#) for details.

In the Big layout, the Info row shows decompression information as described in [The Deco Row section on page 13](#).



Default Info row in OC Rec mode, Big layout

The default configuration of the Info row in the Standard layout varies between different dive modes.

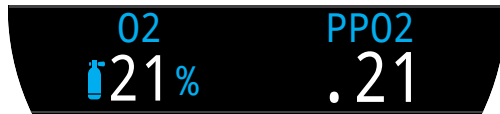

Default Info row in OC Rec mode, Standard layout



Default Info row in OC Tec mode, Standard layout



Default Info row in CC/BO mode, Standard layout

Active Gas

In all three standard layout examples, the first Info row slot is taken by the Active Gas.



In OC Rec mode, the percentage of oxygen in the breathing gas is displayed.



In OC Tec mode, both the fraction of oxygen and the fraction of helium are displayed.

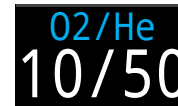

In CC/BO mode, the active gas refers to the diluent gas.

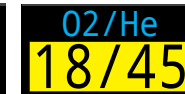

Active gas displays in yellow when a better gas is available.

Partial Pressure of Oxygen (PPO2)



PPO2 of the current breathing gas. Displays in **Flashing Red** when outside customizable PPO2 limits.

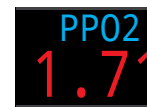

[Read more about PPO2 Limits on page 68.](#)

CC Internal Set point (SP)

The high and low internal set points are color coded.



High Set point is green



Low Set point is magenta



The Bottom Row



Bottom Row, OC Rec Mode on a dive



Bottom Row, CC/BO Mode at the surface

Dive Time



The current length of the dive in minutes and seconds

Surface Interval



When on the surface, the Dive Time is replaced by a surface interval display.

Shows the minutes and seconds since the end of your last dive.

Above one hour, the surface interval is displayed in hours and minutes. Above 4 days, the surface interval is displayed in days.



The surface interval resets when decompression tissues are cleared.

Alternate Active Gas and Set point Location

When the info row is not displaying the active breathing gas (or diluent), or the current internal set point, these values are displayed in the bottom row.

The alternate active gas location is at the very bottom of the computer display.

The alternate set point location is at the far right of the bottom row.

Notification Setting Icon

Indicates what notifications are turned on. Only available at the surface.



Beep Only



Vibrate Only



Beep and Vibrate



Silenced

Alert Indicator



Indicates there is a persistent warning condition.

When the computer detects a dangerous situation, such as high PPO2, a warning is triggered. The large primary warning can be dismissed, but for some critical situations this alert icon will persist until the condition that caused the warning is resolved. See the Alerts section on page 22 for more information.



3.5. Info Screens

Info screens provide more information than is available on the main screen.

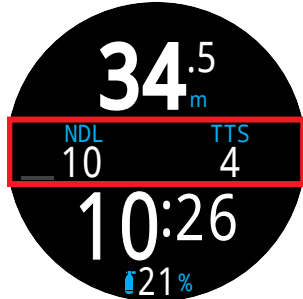

Big layout Info row location



Standard layout Info row location

From the main screen, the INFO (bottom right) button steps through info screens.

When all info screens have been viewed, pressing INFO again will return to the main screen.

Pressing the MENU (bottom left) button will also return to the home screen at any time.

Info screens also automatically time-out after 10 seconds, returning to the home screen. This prevents critical NDL, DECO and TTS information from being hidden for an extended period.

When using the Standard layout, the AI, compass, and Tissues Info screens do not automatically time out.

Note that although these screens are generally representative of the Teric display, info screen content varies for each mode. For example, decompression related info screens are not available in gauge mode.

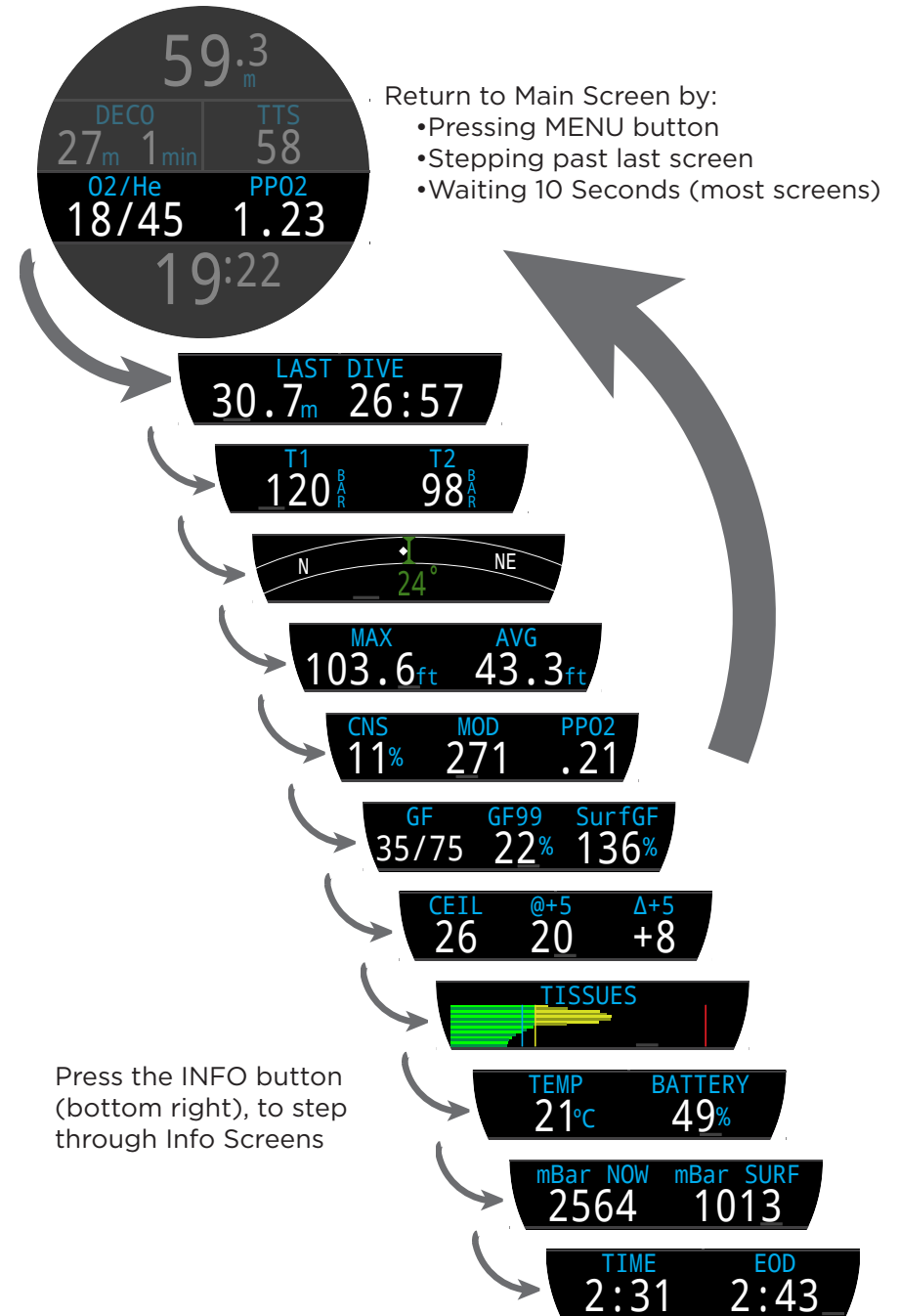



3.6. Info Screen Descriptions

Last Dive Info



Maximum depth and dive time from the last dive. Only available at the surface.

Air Integration (AI)

Only available if AI feature is turned on. The contents of the AI info line will automatically adapt to the current setup.



T1 Only



T1 & GTR/SAC

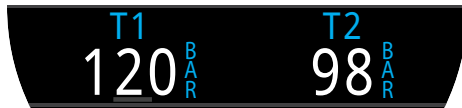

T1 & T2

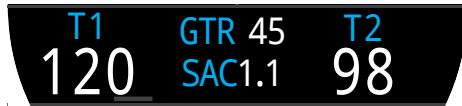

T1, T2 & GTR/SAC

Note that GTR and SAC are only available for a single tank (selectable) and GTR is not available when in deco.

More information about AI displays can be found in [“AI Displays” on page 49.](#)

Compass

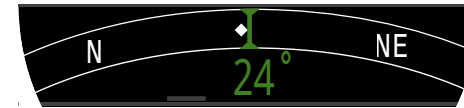

Marked headings appear in green while reciprocal headings are shown in red. Green arrows point in the direction of your mark when off course by 5° or more.

Compass info row will not time out in Standard layout. It is only available when compass feature is turned on.

[See section 8.1 for more information on compass calibration and use.](#)

Maximum Depth



The maximum depth of the current dive. When not diving, displays the maximum depth of the last dive

Average Depth



Displays the average depth of the current dive, updated once per second. When not diving, displays the average depth of the last dive.

Maximum Operating Depth



In OC mode MOD is the maximum allowable depth of the current breathing gas as determined by PPO2 limits.

In CC mode, MOD is the maximum depth of the diluent.

Displays in **Flashing Red** when exceeded.

[Read more about PPO2 Limits on page 68.](#)



Partial Pressure of Oxygen in Diluent

DilPO2
.21

DilPO2 displays the partial pressure of oxygen in the diluent gas PPO2. Displays in **Flashing Red** when outside customizable PPO2 Limits.

DilPO2
1.77

When performing a manual diluent flush, you can check this value to see what the expected PPO2 will be at the current depth.

CNS Toxicity Percentage

CNS
11%

Central Nervous System oxygen toxicity loading percentage. Turns **Yellow** when greater than 90%. Turns **Red** when greater than 150%.

CNS
101%

The CNS percentage is calculated continuously, even when on the surface and turned off. When deco tissues are reset, the CNS will also be reset.

The CNS value (short for Central Nervous System Oxygen Toxicity) is a measure of how long you have been exposed to elevated partial pressures of oxygen (PPO2) as a percentage of a maximum allowable exposure. As PPO2 goes up, the maximum allowable exposure time goes down. The table we use is from the NOAA Diving Manual (Fourth Edition). The computer linearly interpolates between these points and extrapolates beyond them when necessary. Above a PPO2 of 1.65 ATA, the CNS rate increases at a fixed rate of 1% every 4 seconds.

During a dive the CNS never decreases. When back at the surface, a half-life of elimination of 90 minutes is used. So for example, if at the end of the dive the CNS was 80%, then 90 minutes later it will be 40%. In 90 more minutes it will be 20%, etc. Typically after about 6 half-life times (9 hours), everything is back close to equilibrium (0%).

Gradient Factor

GF
35/75

The deco conservatism value when the deco model is set to GF. The low and high gradient factors control the conservatism of the Bühlmann GF algorithm. See “Clearing up the Confusion About Deep Stops” by Erik Baker for more information.

GF99

GF99
22%

The current gradient factor as a percentage (i.e. super-saturation percent gradient)

0% means the leading tissue super-saturation is equal to ambient pressure. Displays “On Gas” when tissue tension is less than the inspired inert gas pressure.

100% means the leading tissue super-saturation is equal to the original M-Value limit in the Bühlmann ZHL-16C model.

GF99 is displayed in **Yellow** when the current gradient factor modified M-Value (GF High) is exceeded.

GF99 is displayed in **Red** when 100% (un-modified M-Value) is exceeded.

SurfGF

SurfGF
136%

The surfacing gradient factor expected if the diver instantaneously surfaced.

SurfGF colour is based on the current GF (GF99). If the current GF is greater than GF High, SurfGF will be displayed in **Yellow**. If the current gradient factor is greater than 100%, SurfGF will be displayed in **Red**.



Ceiling

CEIL
8

The current decompression ceiling not rounded to the next deeper stop increment. (i.e. not a multiple of 10ft or 3m)

@+5

@+5
20

“At plus 5” is the TTS if remaining at the current depth for 5 more minutes. This can be used as a measure of how fast you are on-gassing or off-gassing.

Δ+5

Δ+5
+8

The predicted change in TTS if you were to stay at the current depth for 5 more minutes.

A positive “Delta plus 5” indicates that you are on-gassing the leading tissue while a negative number indicates that you are off-gassing the leading tissue.

Temperature

TEMP
21°C

The current temperature in degrees Celsius or degrees Fahrenheit. Temperature units can be set in the Display settings menu.

Battery

BATTERY
49%

The Teric’s remaining battery level expressed as a percentage.

Displays in yellow when battery is low and needs to be recharged. Displays in red when battery is critically low and must be recharged immediately.

Pressure

mBar NOW mBar SURF
2564 1013

The pressure in millibars. Two values are shown, the surface (surf) pressure and the current (now) pressure.

Note that typical pressure at sea level is 1013 millibar, although it may vary with the weather (barometric pressure). For example, in a low pressure system surface pressure may be as low as 980 millibar, or as high as 1040 millibar in a high pressure system.

For this reason, the PPO2 displayed on the surface may not exactly match the FO2 (fraction of O2), although the displayed PPO2 is still correct.

The surface pressure is set based on the lowest pressure the Teric sees in the 10 minutes prior to the start of a dive. Therefore, altitude is automatically accounted for and no special altitude setting is required.

Time

TIME
2:31

In a 12 or 24 hour format. Time format can be changed in the watch settings menu.

End of Dive Time (EOD)

EOD
2:43

This is similar to TTS but is expressed as a time of day.

The time of day at which you can expect to surface if you depart immediately, ascend at 10mpm or 33fpm, change gases when prompted, and perform all decompression stops as directed.



Tissues Bar Graph



The tissues bar graph shows the tissue compartment inert gas tissue tensions based on the Bühlmann ZHL-16C model.

The fastest tissue compartment is shown on the top, and the slowest on the bottom. Each bar is the combined sum of the nitrogen and helium inert gas tensions. Pressure increases to the right.

The vertical Cyan line shows the inert gas inspired pressure. The yellow line is the ambient pressure. The red line is the ZHL-16C M-Value pressure.

Tissues that are supersaturated above ambient pressure are shown in yellow, and tissues that are supersaturated above the M-Value are shown in red.

Note that the scale for each tissue compartment is different. The reason the bars are scaled in this way is so that the tissues tensions can be visualized in terms of risk (i.e. how close they are as a percentage to Bühlmann's original super-saturation limits). Also, this scale changes with depth, since the M-Value line also changes with depth.

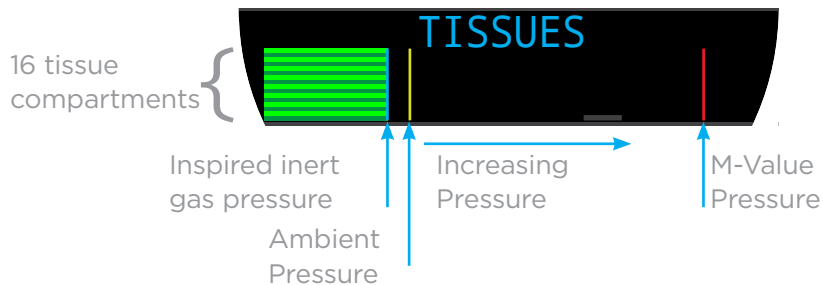

Sample Tissue Bar Graphs



On surface (sat. with air)
Note: Gas is 79% N₂ (21% O₂, or Air)



Immediately after descent



On Gassing



Deep Stop



Last deco Stop
Note: Gas is now 50% O₂ and 50% N₂



3.7. Home Screen Customization

In the Standard layout, the Home screen (first page) Info Row is customizable with 1, 2 or 3 items.

Each Dive Mode's home screen can be customized independently.

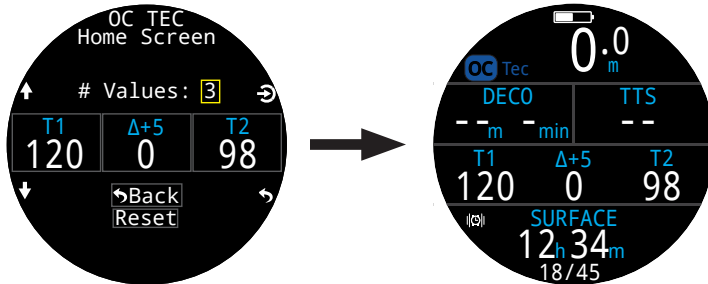
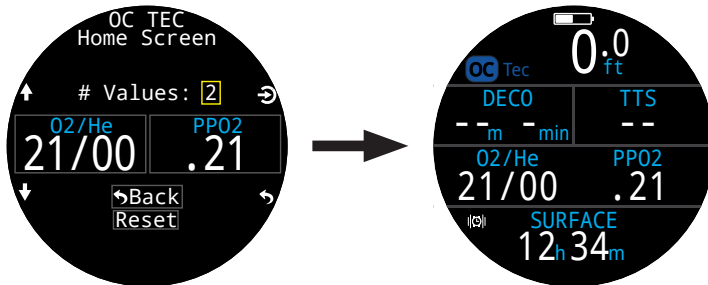

In Open Circuit Rec mode, the right slot of the Info Row and the right Deco Row slot in standard mode are also customizable.

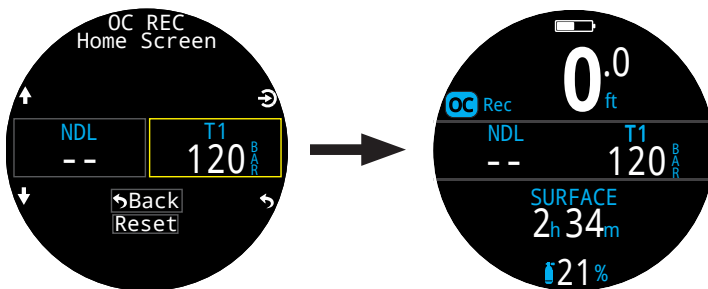

Details about how to customize the Home screen can be found on page 65.

Home Screen Customization Options

Option	Info Display	Option	Info Display
Current Gas	O2/He 18/45 O2 21%	T1 Pressure	T1 120
PPO2	PP02 .21	T2 Pressure	T2 120
CNS %	CNS 11%	GTR	GTR T1 45
MOD	MOD 57	SAC	SAC T1 1.1
Deco Consvr	GF 35/75	Tx & GTR	T1 120 GTR 45
GF99	GF99 22%	Tx & SAC	T1 120 SAC 1.1
Ceiling	CEIL 8	GTR & SAC	GTR 45 SAC 1.1
@+5	@+5 20	T1 & T2	T1 120 T2 98
Δ+5	Δ+5 0	Time of Day	TIME 2:31
Tissues	TISSUES	Date	DATE MAY-30
Surf. GF	SurfGF 136%	Stopwatch	STOPWATCH 4:57
TTS	TTS 14	End of Dive	EOD 2:43
NDL	NDL 20	t@Max Depth	t@MAX 12:14
Set Point	SP 1.3	Temperature	TEMP 21°C
Dil. PPO2	DilP02 .21	Compass°	Compass 55°
Max Depth	MAX 31.6m	Battery %	BATTERY 49%
Avg. Depth	AVG 13.3m	mBar Now	mBar NOW 2564
		mBar Surf.	mBar SURF 1013



3.8. Alerts

This section describes the different types of alerts and how the diver is notified of them.

For a list of the alerts a diver may encounter see [Warnings and Information Displays on page 83](#)

Types of alerts

Dive Events

Alert the user of non-critical dive events.

No specific action is required on the part of the diver.



Dive Events time out after 4 seconds or can be cleared by pressing any button.

Warnings

Alert the user to critical safety information.

The cause of warnings could be life threatening if not immediately addressed.



Warnings can only be cleared manually by the user. Press any button to acknowledge and clear a warning.

For some critical conditions, the alert indicator will persist on screen until the warning condition abates.



Errors

Alert the user to system errors.

Errors represent unexpected system behavior. Contact Shearwater if you experience a system error.



Color Coding

Color coding of text draws attention to problems or unsafe situations.

WHITE text indicates normal conditions by default.

Note that this normal condition color can be selected in the Settings > Display > Colors menu.

YELLOW is used for warnings that are not immediately dangerous but should be addressed.



Sample warning - a better gas is available

FLASHING RED is used for critical warnings that could be life threatening if not immediately addressed.



Sample critical alert - Continuing to breathe this gas could be fatal



Color blind users

The warning or critical alert states can be determined without the use of color.

Warnings display on a solid inverted background.



Doesn't flash.

Critical alerts flash between inverted and normal text.

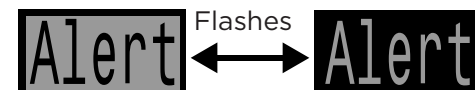



Persistent Alerts

When the computer detects a dangerous situation, such as high PPO2, a warning is triggered. The large primary warning can be dismissed, but the alert indicator will persist until the condition that caused the warning is resolved.



Pressing the menu button while the alert icon is present will display the warnings overlay which lists all of the current persistent alerts in order of priority.



Pressing the menu button a second time brings up the main menu as normal.

Audible and Vibration Alerts

In addition to visual alerts, the Teric has audible and vibration alerts to help quickly notify the diver of warnings, errors and dive events.

The alert notifications settings can be changed in Main menu > Alerts.



It's important the diver is aware of what type of alert notification they can expect on a dive. The currently selected alert notifications are shown on:

- The owners information screen
- The surface screen

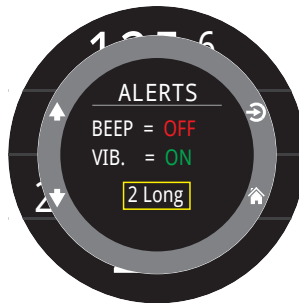

A Test Alerts tool is also available in the Dive Tools menu and should be used regularly before diving to ensure the beeper and vibrator are functioning properly.



If you do not like audible or vibrating alerts, they are easily silenced.



Limitations Of Alerts

All alarm systems share common weaknesses.

They can alarm when no error condition exists (false positive). Or they can fail to alarm when a real error condition occurs (false negative).

So by all means respond to these alarms if you see them, but NEVER depend on them. Your judgment, education, and experience are your best defenses. Have a plan for failures, build experience slowly, and dive within your experience.



4. Safety and Decompression Stops

Safety and decompression stops are pauses inserted into the ascent to the surface in order to reduce the risk of decompression illness (DCI).

4.1. Safety Stops

A safety stop is an optional stop added to all dives before surfacing. Safety stops can be set to fixed times of 3, 4, or 5 minutes, set to adapt based on dive conditions, or turned off completely. See Deco Settings.

The Teric does not do “deep safety stops”. That is, there are no extra stops added around 15m to 18m (50ft to 60ft) when ascending from a no-deco dive.

Safety stops behave as follows:

Safety Stop Required

Once the depth exceeds 11m (35ft), a safety stop will be required. An alert will occur when in the safety stop depth range, shallower than 6m (20ft).



Automatic Countdown

Countdown begins once the depth becomes shallower than 6m (20ft).

Countdown will continue while the depth remains in the range of 2.4m to 8.3m (7ft to 27ft).



Countdown Paused

If the depth goes outside of the range 2.4m to 8.3m (7ft to 27ft), then the countdown pauses, and the remaining time displays in yellow.



Safety Stop Complete

When the countdown reaches zero, the display changes to “Clear” and you are now clear to ascend to the surface.



Countdown Reset

The countdown will reset if the depth once again exceeds 11m (35ft).



No Lockout for omitting

There is no lock-out or other penalty for omitting a safety stop, as they are optional.

If you ascend to the surface before the safety stop countdown finishes, the safety stop will appear paused, but this will disappear once the dive ends.

We recommend performing safety stops as planned as they offer a reduction in risk of DCI and take little time.

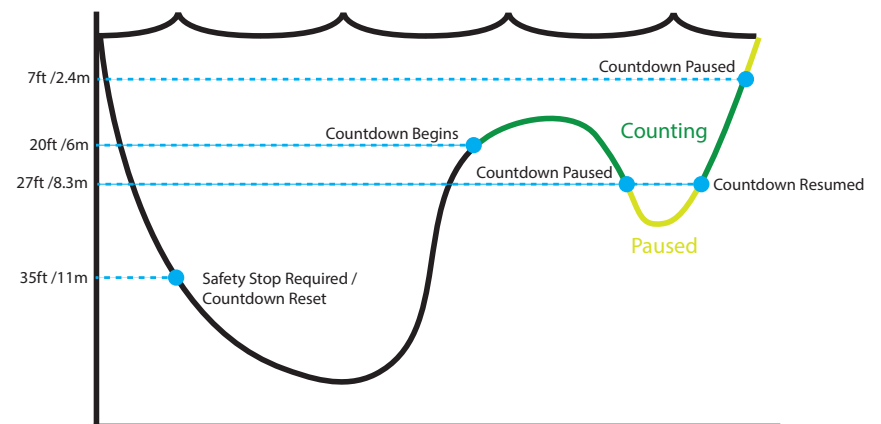

Safety Stop Thresholds - Not to scale



4.2. Decompression Stops

Decompression stops are mandatory stops that must be followed in order to reduce the risk of decompression illness (DCI)



Do not dive beyond your training

Only perform decompression diving if you have received proper training to do so.

Diving with any type of overhead ceiling, whether in a cave or shipwreck, or from a decompression requirement, adds significant risk. Have a plan to handle to failures and never rely solely on a single source of information.

Decompression stops occur at fixed 10ft (3m) intervals.

Decompression stops display as follows:

Replaces NDL

Once the NDL reaches zero, deco stop information will replace it on the left side of the Deco Row in the Standard layout, or the left side of the info row home screen in the Big layout.



In OC Rec mode, the deco stop label appears in red as deco obligation is an emergency condition in recreational diving.



Deco Stops Required

An alert will indicate when Deco Stops are required



Deco Stop Violation

If you ascend shallower than a deco stop, but remain deeper than your current ceiling, stop info will display in yellow.



If you ascend shallower than your current ceiling, the display will flash red. Significant stop violations will result in a "MISSED STOP" alert.



Deco Stops Complete

In OC Tec mode, once all decompression stops are complete, a "Deco Clear" dive info event will be triggered.

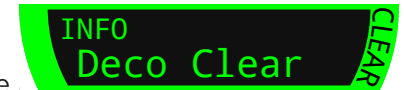

If enabled, the Deco Clear counter will begin counting up from zero.

In OC Rec mode, once all decompression stops are complete, the safety stop will begin counting down

If safety stops or the Deco Clear Counter is turned off, the display will say "Clear".



No Lockout for violating Deco Stops

There is no lock-out or other penalty for violating decompression stops.

The policy is to provide clear warnings that the decompression scheduled was violated, to allow you to make decisions based on your training.

This may include contacting your dive insurance provider, contacting the nearest recompression chamber, or performing first aid based on your training.



5. Decompression and Gradient Factors

The basic decompression algorithm used by this computer is Bühlmann ZHL-16C. It has been modified by the use of Gradient Factors that were developed by Erik Baker. We have used his ideas to create our own code to implement it. We would like to give credit to Erik for his work in education about decompression algorithms, but he is in no way responsible for the code we have written.

The computer implements Gradient Factors creating varied levels of conservatism. The levels of conservatism are pairs of number like 30/70. For a more detailed explanation of their meaning, please refer to Erik Baker's excellent articles: "Clearing Up The Confusion About Deep Stops" and "Understanding M-values". The articles are readily available on the web. You might also want to search for "Gradient Factors" on the web.

The default of the system depends on the dive mode

For OC Rec mode the default conservatism setting is medium (40/85).

For OC Tec and CC/BO modes where some decompression is presumed, the default is a more conservative 30/70. The system provides several settings that are more aggressive than the default.

Do not edit GF values until you understand the effects.

Graph from Erik Baker's "Clearing Up The Confusion About Deep Stops"
Pressure Graph: Gradient Factors

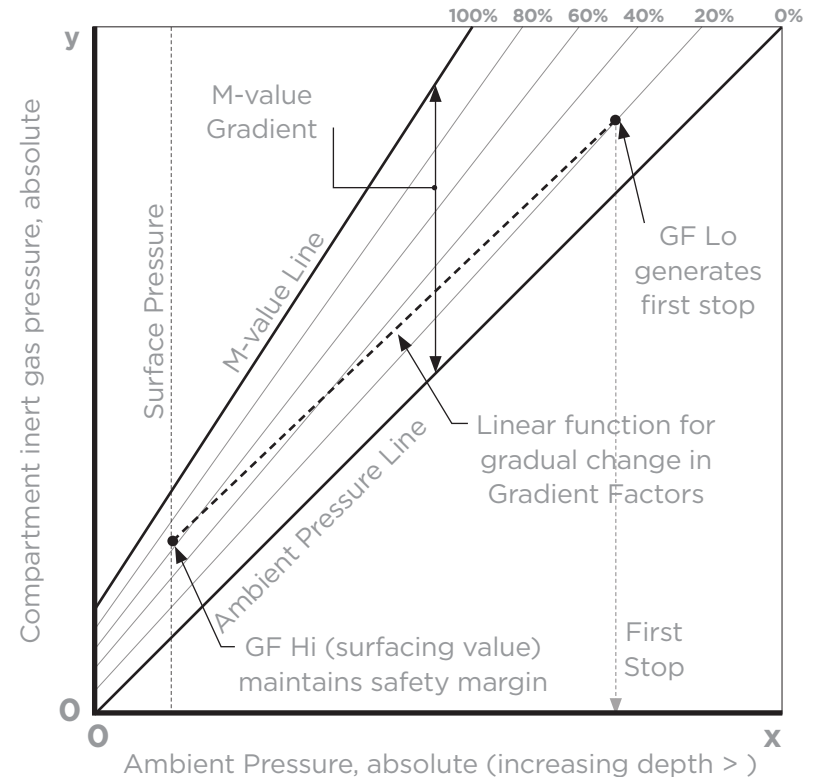

- A Gradient Factor is simply a decimal fraction (or percentage) of the M-value Gradient.
- Gradient Factors (GF) are defined from 0% to 100%.
- A Gradient Factor of 0% represents the ambient pressure line.
- A Gradient Factor of 100% represents the M-value line.
- Gradient Factors modify the original M-value equations for conservatism within the decompression zone.
- The lower Gradient Factor value (GF Lo) determines the depth of the first stop. Used to generate deep stops to the depth of the "deepest possible deco stop"
- The higher Gradient Factor value (GF Hi) determines the surfacing tissue supersaturation.



5.1. Decompression Information Accuracy

Decompression information displayed by this computer, including NDL, stop depth, stop time, and TTS are predictions. These values are continuously recalculated and will change with changing conditions. The accuracy of these predictions is dependent on several assumptions made by the decompression algorithm. It is important to understand these assumptions to ensure accurate decompression predictions.

It is assumed that the diver's ascent rate is 10m/min (33ft/min). Ascending significantly faster or slower than this will impact decompression obligations. It is also assumed that the diver is carrying and plans to use every gas that is currently turned on. Leaving gases that are not expected to be used turned on will result in inaccurate time to surface, decompression stop and decompression time information being displayed.

On ascent, it is assumed that the diver will perform decompression stops using the gas with the highest PPO₂ below the OC Deco PPO₂ value (default 1.61). If there is a better gas available, the current gas will be displayed in yellow, indicating that a gas change is expected. The decompression prediction displayed always assumes that the best gas will be used. Even if the switch to a better gas has not been completed yet, decompression predictions will be displayed as if the switch is about to occur in the next 5 seconds.

Divers can encounter longer than expected decompression stops as well as inaccurate time to surface predictions if they fail to switch to a better gas when prompted by the computer.

Example: A diver on a decompression dive to 40m/131ft for 40 minutes with GF settings of 45/85 has two gases programmed into their computer and turned on: 21/00 & 99/00. The diver's decompression schedule will be calculated based on breathing 21% oxygen for the descent, bottom and ascent phases of the dive until the diver ascends to 6m/20ft. At 6m/20ft the PPO₂ of the 99/00 mix is 1.606 (less than 1.61), so it is the best decompression gas available.

Decompression information for the remaining stops will be calculated and displayed assuming the diver is going to switch to this better gas. This dive profile indicates these stops would be 8 minutes at 6m/20ft and 12 minutes at 3m/10ft. If the diver never makes the switch to 99/00, the computer will not allow them to surface until adequate off-gassing has occurred, but it will continue to assume the diver is about to make the gas switch and the decompression times given will be grossly inaccurate. The 6m/20ft stop will take 19 minutes to clear and the 3m/10ft stop will take 38 minutes to clear. That is a total time to surface difference of 37 minutes.

In a lost gas scenario or in the event a diver forgets to turn off a gas they are not carrying before a dive, gases can be turned off during the dive in Main menu -> Edit Gases.



6. Example Dives

6.1. OC Rec Example Dive

This is an example of displays that might be seen on a simple no-decompression dive in OC Rec Mode using the Big layout configuration.

1. Pre-Dive - This is the surface screen immediately before descending. At the surface, the cyan OC Rec icon is visible, the battery is shown to be about half full, and the Alerts are set to sound and vibrate.
2. Descent - As we pass through 9 meters, the time-to-surface (TTS) shows one minute. This shows that the computer expects the diver to ascend at 10 meters per minute or 33 feet per minute. All decompression (and NDL) predictions are based on this assumed ascent rate. A safety stop is not included for dives shallower than 11m (35ft).
3. Max Depth - The no-decompression limit starts off showing 99, but then starts to show smaller numbers as depth increases. The 3rd screen shows that we will go into deco in 10 minutes. A 5 minute safety stop is now included in the predicted TTS.
4. Low NDL - When the NDL goes below 5 minutes, it turns yellow indicating that we should begin making our ascent to avoid a decompression obligation
5. Ascent - As we ascend our NDL begins increasing again indicating that we can stay a bit longer at this shallower depth. The ascent rate indicator shows that we are ascending at about 6 mpm or 22 fpm.
6. Safety Stop - When we ascend shallower than 6m we are prompted to perform a safety stop. In this case the safety stop setting has been set to Adapt, and because of our deep profile, the countdown began at 5 minutes. A CLEAR indicator will inform us when the safety stop has been completed.

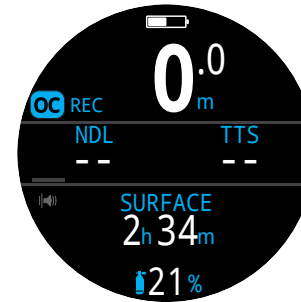

1. Pre-Dive



2. Descent



3. Max Depth

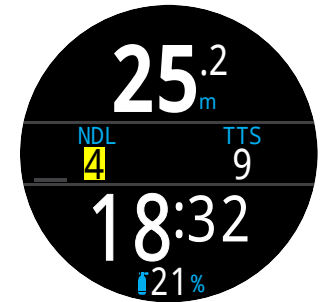

4. Low NDL



5. Ascent



6. Safety Stop



Although safety stops are not mandatory, gas supply permitting, best practice is to perform a safety stop on every dive.



6.2. OC Tec Example Dive

This is an example of displays that might be seen on a multi-gas decompression dive in OC Tec Mode using the Standard layout configuration.

Max Depth: 60 meters	Bottom Gas: Trimix (18/45)
Bottom Time: 20 minutes	Deco Gases: 50% & 99% O ₂

1. OC Gas Setup - Best practices include checking your gas list before each dive. This screen is available in the Edit Gases section of the main menu in Dive Mode. All gases that are turned on will be used to calculate the decompression scheduled. Make sure to turn off gases you are not carrying.

2. Verify Decompression Settings - It is also prudent to ensure all other settings are correct before starting every dive. In addition to checking gases, we recommend verifying values in Dive and Deco Settings.

3. Plan Dive - Use the dive planner found in Dive Tools to check the total runtime, decompression scheduled and gas requirements for the dive.

The on-board deco planner is limited in functionality, so for complex dives we recommend using desktop or smart phone dive planning software.

4. Pre-Dive - Prior to beginning the dive we can see from the mode indicator that we are in OC Tec mode. Our active gas is currently 18/45, our battery is about half charged, and only vibration alerts are active.

5. Descent - As we descend our dive time begins counting, the Deco Box begins showing our NDL.

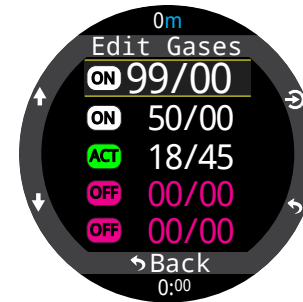

1. OC Gas Setup

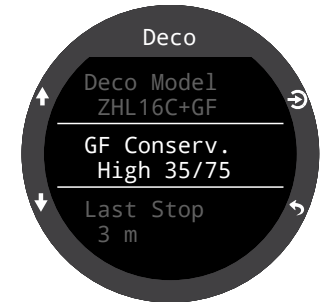

2. Verify Deco Settings



3. Plan Dive - Deco Scheduled

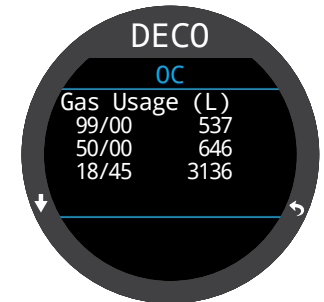

3. Plan Dive - Gas Requirement

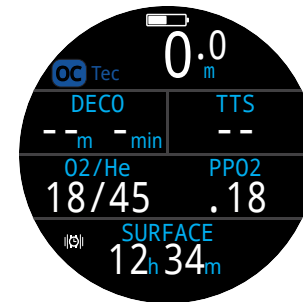

4. Pre-Dive

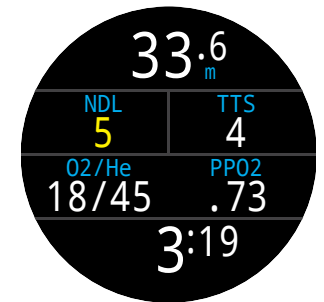

5. Descent

(Continued on next page)



OC Tec Example Dive (cont.)

6. Max depth - Once NDL hits 0, deco stops will be needed. Stop requirements display in the deco box in place of the NDL. TTS has increased to include deco stop time.

7. Ascent - It is safe to ascend to 24 meters. 2 minutes must be spent at that deco stop. While ascending, the bar graph to the right of the depth shows the ascent rate (10 mpm). All decompression predictions are made assuming an ascent rate of 10 meters per minute.

8. Gas Change - All decompression predictions are made assuming you will switch to the best available gas on ascent. At the 21m stop, the breathing gas turns yellow indicating that a better breathing gas is available. If the switch is not made, deco stop and time information will be inaccurate.

9. Missed Deco Stop - If you ascend shallower than the decompression ceiling the Deco information will flash red. If you fail to descend, a missed deco stop warning will be triggered and the Alert icon will appear. Acknowledge and clear the warning by pressing any button. Re-descend deeper than the stop depth to clear the flashing text and alert icon.

10. Deco Clear - Once all decompression obligation has been cleared, the deco clear counter begins counting up from zero.

End of example.

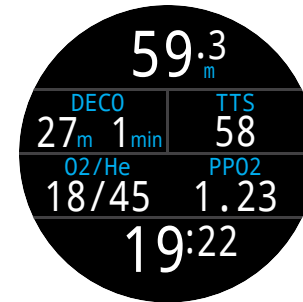

6. Max Depth

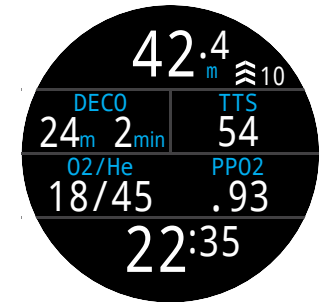

7. Ascent

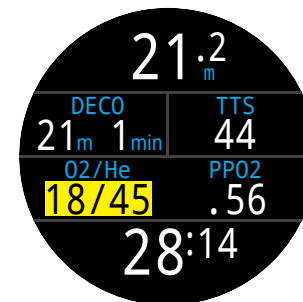

8. Gas Change



9. Missed Deco Stop

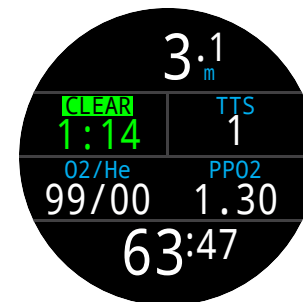

10. Deco Clear



6.3.CC Example Dive

This is an example of displays that might be seen on a multi-gas decompression dive in CC/BO Mode using the Standard layout configuration.

Max Depth: 90 meters	Diluent Gas: Trimix (10/50)
Bottom Time: 20 minutes	Bailout Gases: 14/55, 21%, 50%

1. CC Gas Setup - Best practices include checking your gas list before each dive. This screen is available in Edit Gases section of the main menu in CC mode. For this dive the only diluent gas is Trimix 10/50. (10% O₂, 50% He, 40% N₂)

2. OC Gas Setup - Several OC gases are required for this dive. If we switch to BO mode, we can use the Edit gases section of the main menu to define our bailout gases as well.

We will verify we are carrying sufficient bailout gas when we plan the dive.

3. Verify Decompression Settings - It is prudent to ensure all other settings are correct before starting every dive. In addition to checking gases, we recommend verifying values in Dive and Deco Settings.

4. Plan Dive - Use the dive planner found in Dive Tools to check the total runtime, decompression schedules and bailout gas requirements for the dive.

For closed circuit dives, two decompression schedules will be generated. A primary schedule for closed circuit deco, and a bailout decompression schedule.

The on-board deco planner is limited in functionality, so for complex dives we recommend using desktop or smart phone dive planning software.

(Continued on next page)

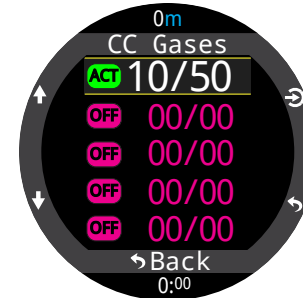

1. CC Gas Setup

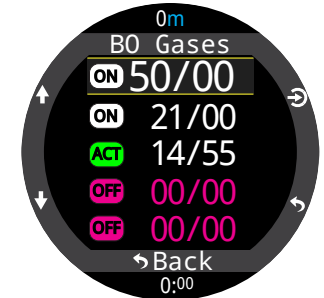

2. OC Gas Setup

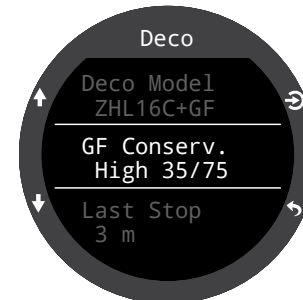

3. Verify Deco Settings



4. Plan Dive - CC Scheduled

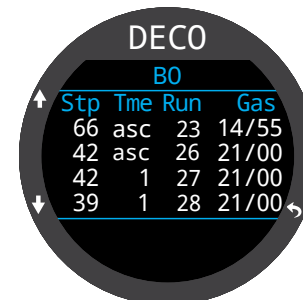

4. Plan Dive - BO Scheduled

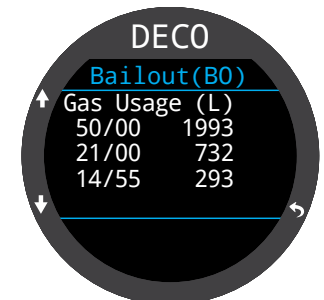

4. Plan Dive - Bailout Gas Requirement



CC Example Dive (cont.)



Note on Hypoxic Diluents

Hypoxic diluents such as 10/50 in this example require special training since they can be deadly near the surface.

5. Pre-Dive - Prior to beginning the dive we can see from the mode indicator that we are in CC mode. Our active diluent gas is set to 10/50, our set point is 0.7, the Teric's battery is about half charged, and only vibration alerts are active.

6. Diluent Check - Pressing INFO a few times brings up the info screen that shows the diluent PPO2. The red indicates it is unsafe to breath directly.

This information can be viewed at any time to verify the diluent is safe or to check what the expected PPO2 will be when flushing with diluent at depth.

7. Automatic Set point Switch - The optional auto set point switch was enabled with a depth setting of 15m. So as we cross 15m on the descent, the set point automatically switches from 0.7 to 1.3.

8. Decreasing NDL - As we descend deeper, the NDL decreases. The TTS shows it will take 5 minutes to ascend to the surface at 10m/min (33ft/min).

9. Bottom Time - We have completed the bottom time. The TTS indicates we have about 1.5 hours of decompression to do. The first stop will be at 48m for 1 minute.

10. Ascending to the First Stop - Here we are ascending at 3m/min. This is slower than the expected 10m/min ascent rate. This slow ascent has caused the TTS to rise, as most tissues are still on-gassing.

(Continued on next page)

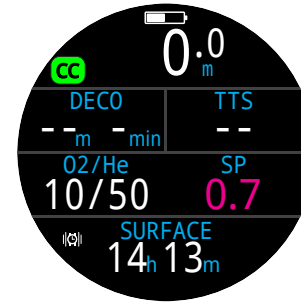

5. Pre-Dive



6. Diluent Check

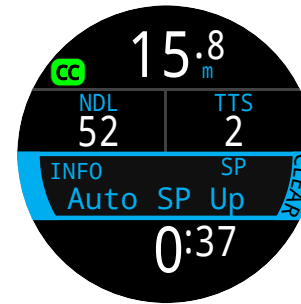

7. Automatic Set point Switch

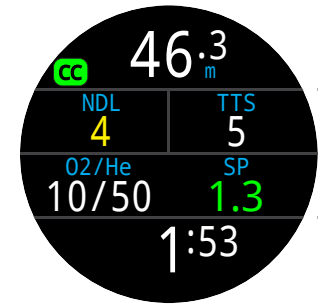

8. Decreasing NDL

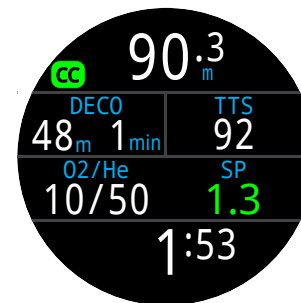

9. Bottom Time



10. Ascending to First Stop



CC Example Dive (cont.)

11. First Deco Stop - The slow ascent has caused the first stop to clear before we reached it. This often happens with slow ascents.

12. A Problem Has developed - There is a problem with the O2 readings on the rebreather controller and the decision has been made to bail out. After physically switching the BOV or mouthpiece, the computer needs to be set to BO mode for proper deco calculations.

13. Bailout - One Press of the MENU button brings up "SWITCH CC -> BO" as the first menu item. Pressing SELECT (FUNC button) makes the change.

Note the Dive Mode indicator has changed to BO to indicate the bailout condition. The info row has also changed to reflect the customization settings for BO mode. The best BO gas was automatically selected, and the deco schedule has been adjusted based on the BO gases.

14. Gas Switch Required - We are now at 21m, having completed a few more deco stops. The gas is now displaying in yellow, indicating a better gas is available.

15. Gas Switch - Pressing MENU twice brings up the "SELECT GAS" option in the main menu, and pressing SELECT (FUNC button) enters it. The best gas will already be the initial selection, just press SELECT once more time to make it the active gas.

16. Deco Clear - Follow the deco stops until they have all cleared and the Deco Clear Counter begins counting up from zero.



11. First Deco Stop



12. A problem has developed

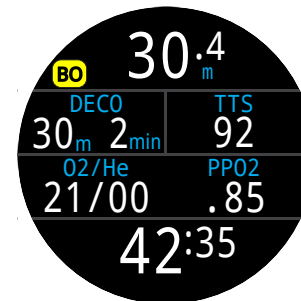

13. Bailout



14. Gas Switch Required

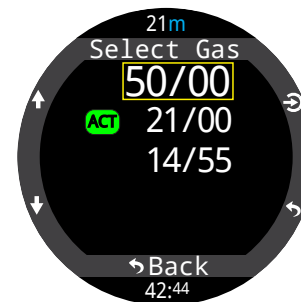

15. Gas Switch



16. Deco Clear

End of example.



6.4. Gauge Mode

Gauge Mode turns the Teric into a simple depth and time display (a.k.a. a bottom timer).

Since decompression tissues are not tracked in Gauge Mode, changing to or from Gauge Mode resets the deco tissues.

By default, gauge mode is displayed in “Big” layout with the Max depth and Stopwatch shown in the info row.

Change to the Standard layout configuration for additional on screen information and increased customizability.

[Learn about home screen customization options on page 21.](#)

While on the surface, the MAX and AVG values display the maximum and average depth of the last dive. The AVG depth displayed on the surface is for the entire dive, regardless of whether the reset average depth option was used. The dive log also records the average depth for the entire dive.

Gauge Mode Features:

- Resettable average depth
- Stopwatch

(These features are available in all modes)



Big layout - Default Gauge Mode configuration.



Standard layout - Alternate Gauge Mode configuration.



7. Freedive Mode

Freedive Mode optimizes the Teric for freediving.

Although many of the basic functions of the computer are the same as in other dive modes, Freedive Mode has several unique features that are covered in this section.

Since decompression tissues are not tracked in Freedive Mode, changing to or from Freedive Mode resets the deco tissues.

Free Dive Mode features:

- High Speed depth sampling - 4 samples / second.
- Fully customizable auditory and vibration alerts
- Freedive focused Info screens
- Quick Log Tagging



WARNING

Breath-hold diving involves risks that are not obvious. Do not engage in these activities without proper training as well as a complete understanding and acceptance of the risks.

This manual is not a substitute for professional training.

7.1. Default Freediving Layout

By default, Freedive Mode uses the Big layout. It shares most features with the other dive modes but has a few unique characteristics.

- Active Freediving Set shown beside Mode Indicator.
- Last dive time and max depth on home screen
- Ascent / descent shown in feet per second (fps) or meters per second (mps) instead of fpm / mpm.



Like in OC Rec and Gauge Mode, in Freedive Mode, the right home screen slot can be customized in the Big Layout.



7.2. Freediving Info Screens

Freedive Mode has a unique info screen sequence which can be seen on the right.

Max and average descent and ascent screens are only available in freediving mode (in either fps or mps).

These values can also be added to the home screen in Freedive Mode.



7.3. Freediving Sets

A freedive set is a collection of settings customized for a specific type of freediving.

The Teric supports 3 independently customizable sets. For each set, the user can customize the alerts activated during a dive as well as a handful of settings that will often change between activities. Fresh water in a pool vs salt water in the ocean for example.

See how to Edit Freedive Sets on page 61.

Freedive Mode info screen sequence:

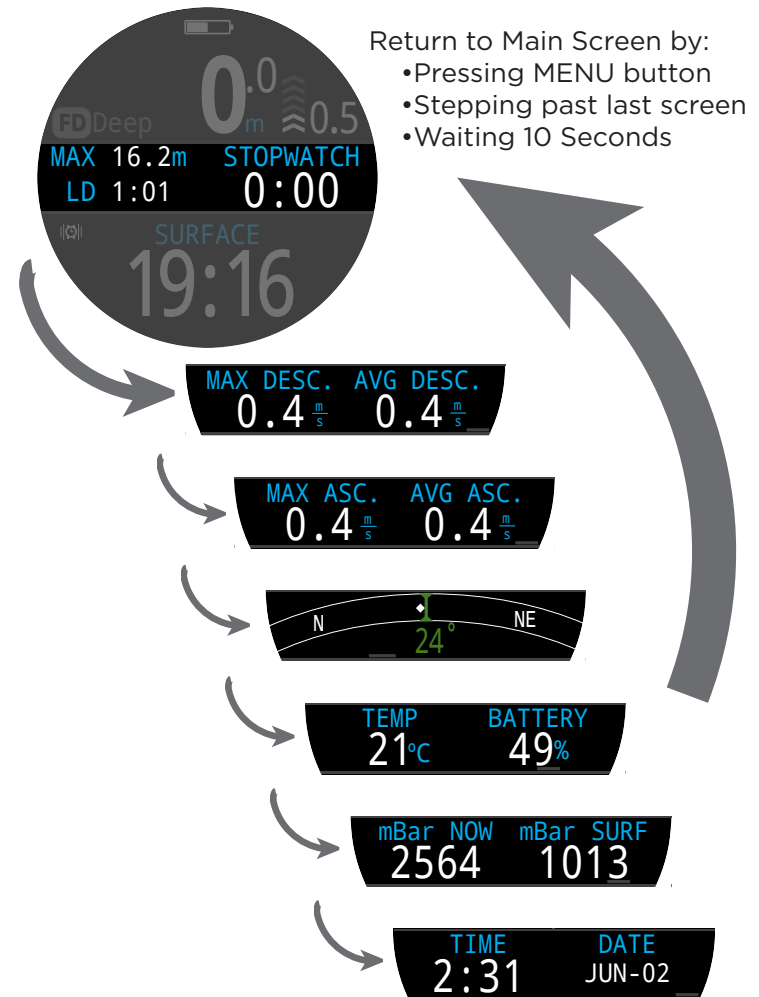

- Return to Main Screen by:
- Pressing MENU button
 - Stepping past last screen
 - Waiting 10 Seconds

Press the INFO button (bottom right), to step through Info Screens



Freediving Alerts

Customizable in each set, these alerts are useful for notifying the diver of different phases of a freedive.

Freediving alerts differ from normal alerts in several ways.

- Only appear for 4 seconds.
- Come in 3 colors depending on urgency.
- Fully customizable within a set.
- Each has a customizable depth or time as a triggering condition

Freediving alert types:

Info - Appears in blue.



Caution - Appears in yellow. Offending triggering condition also turns yellow.



Danger - Appears in Red. Offending triggering condition also turns red.



Depth Alerts:

Notify 1, Notify 2, Warn Depth, and Max Depth all trigger when their respective depth thresholds have been exceeded on decent.

Ascent Alert:

Asc. Notify indicates when a depth threshold has been exceeded on ascent.

Time Alerts:

Notify Time, Warn Time, Max Time, and Surf Time all trigger when time thresholds have been exceeded on a dive or in the case of Surf Time, after the diver has been at the surface for a defined amount of time.

Repeat Alerts:

Depth Repeat, Time Repeat, and Surf Repeat differ from simple depth and time alerts in that they are repeatedly triggered at the user-defined interval.

For example, Time Repeat will vibrate or beep every 15 seconds while diving. This gives the diver a non-visual indication of the passage of time.

All of the freediving alerts are listed in the table below:

<i>Freediving Alert</i>	<i>Trigger Condition</i>	<i>Alert Type</i>
<i>Notify 1</i>	<i>Depth</i>	<i>Info</i>
<i>Notify 2</i>	<i>Depth</i>	<i>Info</i>
<i>Warn Depth</i>	<i>Depth</i>	<i>Caution</i>
<i>Max Depth.</i>	<i>Depth</i>	<i>Danger</i>
<i>Asc. Notify</i>	<i>Depth</i>	<i>Info</i>
<i>Notify Time</i>	<i>Time</i>	<i>Info</i>
<i>Warn Time</i>	<i>Time</i>	<i>Caution</i>
<i>Max Time</i>	<i>Time</i>	<i>Danger</i>
<i>Surf Time 1</i>	<i>Time</i>	<i>Info</i>
<i>Surf Time 2</i>	<i>Time</i>	<i>Info</i>
<i>Depth Repeat</i>	<i>Depth</i>	<i>Info</i>
<i>Time Repeat</i>	<i>Time</i>	<i>Info</i>
<i>Surf Repeat</i>	<i>Time</i>	<i>Info</i>



Regularly test your alerts with the Test Alert tool described on page 41 to ensure they are working and you can hear/feel them through your exposure suit.



Freediving Settings:

Customizable freediving settings include:

- Water Type
- Dive Start Depth
- Dive End Depth
- Dive Start Delay
- Dive End Delay

These settings will vary depending on the location and the type of freediving (ex. dynamic apnea vs. free immersion). So, customizing them within a set, makes it much easier to move between freediving activities without needing to define each setting individually every time.

Note that delays are added back to / removed from dive statistics once the dive is underway. Depth and time information will be the same regardless of the start / end delays and depths.



8. Dive Tools

The Dive Tools can be found in the main menu of every dive mode and can be accessed both at the surface and while diving.

Stopwatch functionality is covered on page 55 in the Watch Tools section.

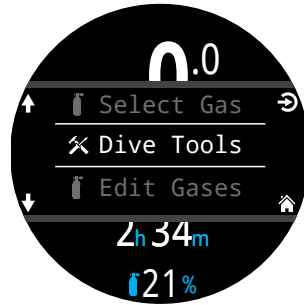

8.1. Compass

The Teric contains a tilt-compensated digital compass.

Compass Features

- Smooth, high speed refresh rate
- Multiple viewing options
- User settable heading marker with reciprocal
- True North (declination) adjustment
- +/- 45 degree tilt-compensation

Viewing the compass

When enabled, the compass can be viewed in three ways:

- As an Info screen
- In the Compass Pop-up
- As an overlay

Compass info screen

Press the INFO button until the info row shows the compass info screen. Unlike the regular info screens, the compass never times out when using the Standard layout.



Compass pop-up

Access the compass pop-up from the Dive tools section of the main menu. The pop-up will time out after 10 seconds.

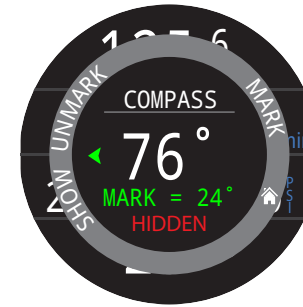

From this pop-up you can mark and unmark headings and show or hide the Outer Ring compass overlay.

The current heading in degrees appears in the center of the pop-up.

Mark a heading

The heading degree mark is displayed at the bottom of the compass pop-up.

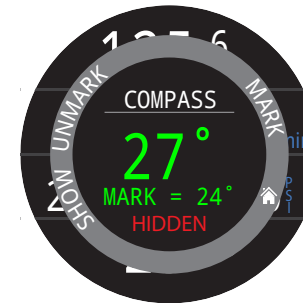

The current heading appears green when within 5 degrees of your mark.

Green arrows indicate the direction of your mark when you are more than 5 degrees off course

A marked heading appears on the compass info screen in green, while the reciprocal heading is shown on the info screen in red. Like on the pop-up, green arrows point in the direction of your mark when off course by 5 degrees or more.





Outer Ring Compass Overlay

The compass overlay can show North and your marked heading at all times.

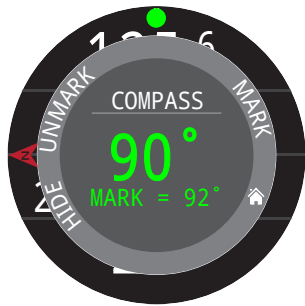

Select “Show” on the compass pop-up to display the compass overlay.

When enabled, a red north arrow and green heading marker will remain at the edge of the screen tracking their marks.



When the overlay is enabled, green arrows at the top of the display indicate the direction of your mark when more than 5 degrees off course.



Check compass calibration before diving

Check compass calibration:

1. Place the Teric on a flat surface, away from metal objects.
2. Mark a heading.
3. Rotate the computer 180 degrees.
4. Ensure the compass is pointing at the reciprocal heading.

See page 73 for compass calibration instructions.



Compass Limitations

It is important to understand some compass limitations before use.

Calibration:

The digital compass needs regular calibration. This can be done in the Settings > Compass menu and takes only one minute. See the compass sub-section of the Settings Menu Reference on page 73 for compass calibration instructions.

Interference:

Metal objects, permanent magnets, and other sources of magnetic interference such as electric motors should be kept away from the compass. We recommend comparing the compass accuracy to a known good compass with and without the interfering object in place to see if it has an effect.

Shipwrecks may interfere with the compass reading and so the compass function should not be used near or inside of a shipwreck. Use the same discretion and training as you would with a traditional compass.

Magnetic declination (also called magnetic variation) is the difference between magnetic and True North. This can be compensated in the Compass Setup menu using the declination setting. The magnetic declination varies around the world, so it will need to be readjusted when traveling.

Magnetic inclination (or magnetic dip) is how much the Earth’s magnetic field points up or down. The Teric’s compass automatically compensates for this angle. However, in some locations (near the poles) the inclination angle can exceed 80° (i.e. the magnetic field points almost directly up or down), in which case the specified accuracy may not be met.



8.2. Tag Log



The tag log feature is useful for marking a point of interest in the dive log for later review. These tags will appear in the dive log when uploaded to your phone or personal computer.

Basic tag titles are available from the tag log pop-up to help distinguish tags.

The tag log pop-up will time out after 10 seconds.

8.3. Reset Average Depth

This feature is useful if you would like to get a sense of the average depth of a particular phase of a dive, such as the bottom, or deco phase. Reset Average Depth is available in every dive mode.

8.4. Test Alerts

The Test Alerts pop-up provides a quick way to ensure your alerts are working and that you are able to feel them through your exposure suit.

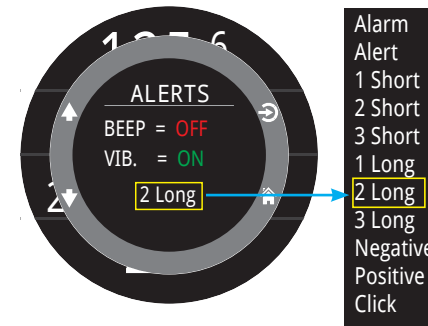

Use the up and down arrows to select an alert and press select to test it.

The Test Alerts pop-up should be used regularly if you use vibration or auditory notifications.

Caution

Although vibration and auditory alerts are very useful, never rely on them for your safety. Electromechanical devices can and will eventually fail.

Always be proactively aware of your depth, no-decompression limit, gas supply, and other critical dive data. You are ultimately responsible for your own safety.



8.5. Deco Planner

Introduction

- Calculates decompression profiles for simple dives.
- Calculates gas consumption based on RMV
- In closed-circuit (CC) mode, also calculates open-circuit bail-out (BO)

The Teric's deco planner is best suited to decompression diving. For no-decompression diving, use the quick [NDL Planner](#) described on page 44.

Setup

The planer uses the current gases programmed into the Teric in the current dive mode, as well as the current GF low/high settings. Deco profile is computed for the current Dive Mode (CC or OC).

When used on the surface



Enter the expected surface interval, bottom depth, bottom time, respiratory minute volume (RMV) and Set Point (closed-circuit only).

Note: Residual tissue loading (and CNS%) from recent dives will be used in calculating the profile



When the correct values are entered, select "Run Plan" and confirm decompression settings and starting CNS.



Important!

The Teric's Deco Planner makes the following assumptions:

- Descent rate is 18m/min (60ft/min) and the ascent rate is 10m/min (33ft/min).
- For OC, the gas in use will be the gas with the highest PPO2 within the PPO2 limits.
- For CC, the diluent in use will be the gas with the highest PPO2 within PPO2 limits.
- The planner will use the configured last stop depth.
- For CC, the PPO2 is constant for the entire dive.
- The RMV is the same while diving as during deco

[Read more about PPO2 Limits on page 65.](#)

When used during a dive

Computes the decompression profile assuming the ascent will begin immediately. There are no settings to enter. (RMV is last used value)

Limitations

The Teric Deco Planner is intended for simple dives. Multi-level dives are not supported.

The Deco Planner does not provide thorough validation of the profile. For example, it does not check for nitrogen narcosis limitations, gas usage limitations, CNS percentage violations, or isobaric counter-diffusion risks due to sudden helium switches.

The user is responsible for ensuring a safe profile is followed.



Results Screens

The results are given in tables showing:

Stp:	Stop Depth	In meters (or feet)
Tme	Stop Time	In minutes
Run	Run Time	In minutes
Gas	Gas Used	%O2/%He

The first few rows will show the bottom time (bot) and the ascent legs (asc) to ascend to the first stop. Multiple ascent legs may be shown if gas switches are needed

If more than 2 stops are needed, the results will be split onto several screens. Scroll down to step through the screens.

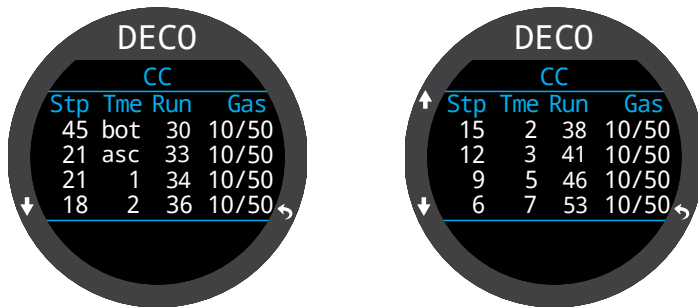

A summary screen shows the total dive time, the time spent on deco and final CNS% after the last page of the decompression schedule.



For CC/BO dives there will be two schedules, one for each operating mode.

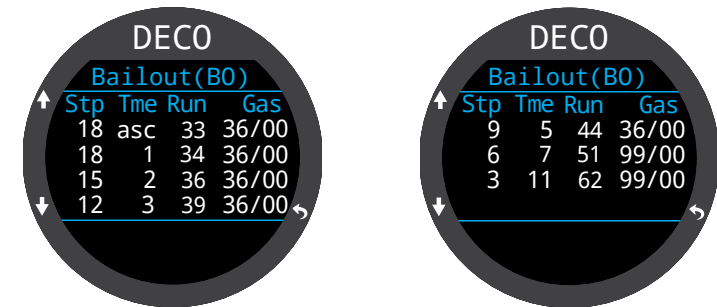

For OC or BO profiles, a total gas consumption report is also given.

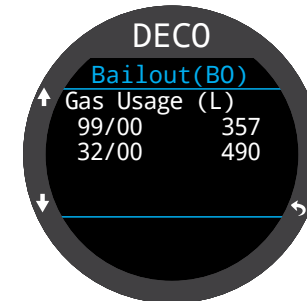

If no decompression is required, no table will be shown. Instead, the total No-Decompression-Limit (NDL) time in minutes, at the given maximum depth will be reported. Also, the gas quantity required to surface (bailout in CC) will be reported.

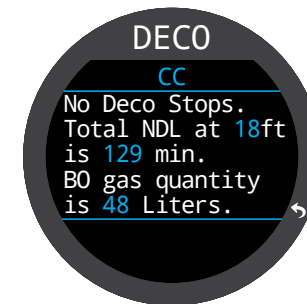



8.6. NDL Planner

The No-Decompression Limit (NDL) Planner is a quick way to determine how much bottom time is available without the need for decompression stops.

A surface interval duration from none up to 1 day can be applied to account for expected off-gassing.

The results are a list of depths, along with the NDL time at that depth and the best of the programmed gases to use at that depth. Only programmed gases are used.

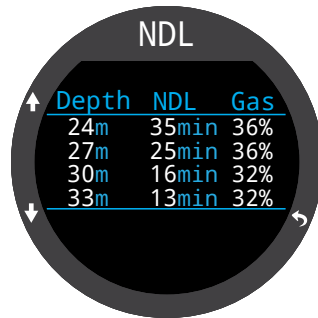



9. Air Integration (AI)

The Teric is equipped with dual transmitter air integration capability.

This section covers operation of the AI feature.

AI Features

- Wireless pressure monitoring of 1 or 2 scuba tanks
- Units in PSI or BAR
- Optional Gas Time Remaining (GTR) and Surface Air Consumption (SAC) rate based on one tank.
- Logging of pressure, GTR and SAC
- Reserve and critical gas pressure warnings.

9.1. What is AI?

AI stands for Air Integration. On the Teric, this refers to a system that uses wireless transmitters to measure the gas pressure in a scuba tank and transmit this information to the Teric dive watch for display and logging.

Data is transmitted using low-frequency (38kHz) radio frequency communications. A receiver in the Teric accepts this data and formats it for display.

The communication is one-way. The transmitter sends data to the Teric, but the watch does not send any data to the transmitter.



Use a backup analog SPG

Always use a backup analog submersible pressure gauge as a redundant source of gas pressure information.

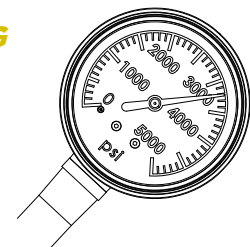



9.2. Basic AI Setup

This section will get you started with the basics of AI on the Teric. Advanced setup and detailed descriptions will be covered in later sections.

Install the Transmitter

Before using the AI system, you will need to install one or more transmitters on a scuba tank first stage regulator.

The transmitter must be installed on a first stage port labeled “HP” (high pressure). Use a first stage regulator with at least two HP ports, so that a backup analog submersible pressure gauge (SPG) can be used.

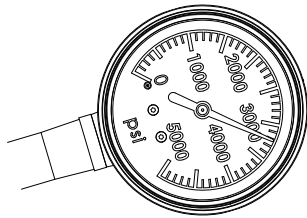

A backup SPG is recommended

Position the transmitter such that it is on the same side of your body as you wear your Teric handset (FIGURE 5). Range is limited to approximately 1 m (3 ft).

A high-pressure hose may be used to relocate the transmitter for better reception or convenience. Use hoses rated for a working pressure of 300 Bar (4500 PSI) or higher.



Use a wrench (11/16” or 17mm) to tighten or loosen the transmitter

Avoid hand tightening or loosening, as this can stress the body of the transmitter.

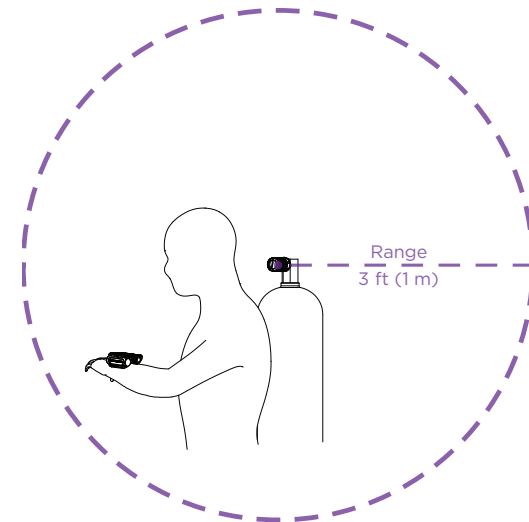
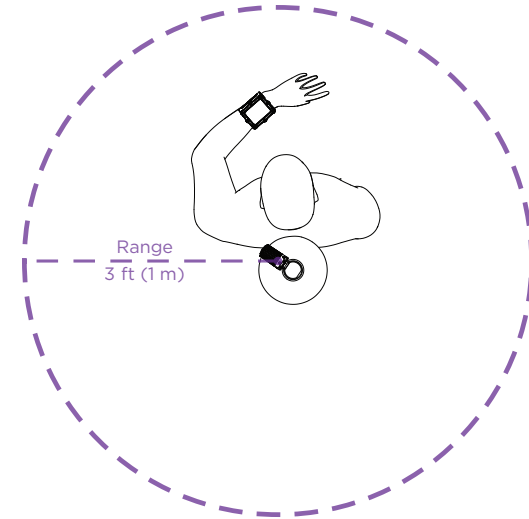

Install transmitter on 1st stage HP port

Install transmitter on the same side of your body as the handset. Range is approximately 3 feet (1 m).



Turn on the Transmitter

Turn on the transmitter by opening the tank valve. The transmitter will automatically wake up when it detects pressure.

Pressure data is transmitted every 5 seconds.

Turn off the Transmitter

To turn off the transmitter, close the tank valve and purge the second stage regulator to drain pressure from the hoses. The transmitter will automatically power down after 2 minutes of no applied pressure.

Leave the valve open and the transmitter on for now.

Enable AI on the Teric

On the Teric, navigate to the **Settings** > **AI** menu. Change the **AI Mode** setting to **T1** (Tank 1). The AI is now on.

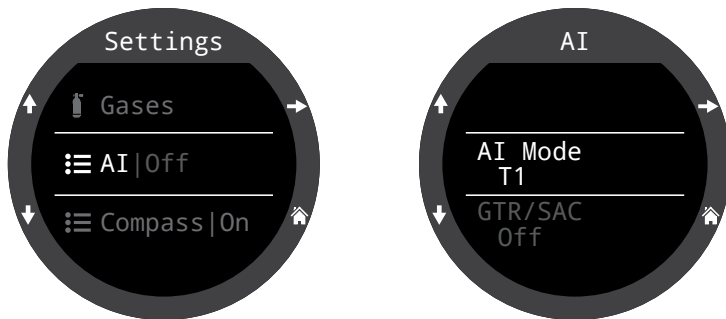

When **AI Mode** is set to **Off**, the AI sub-system is completely powered down and does not consume any power. When on, the AI system increases power consumption by approximately 10%.

More information about settings in the [AI Settings menu](#) can be found on page 72.

Pair the Transmitter

Each transmitter has a unique serial number etched on its body. All communications are coded with this number so that the source of each pressure reading can be identified.

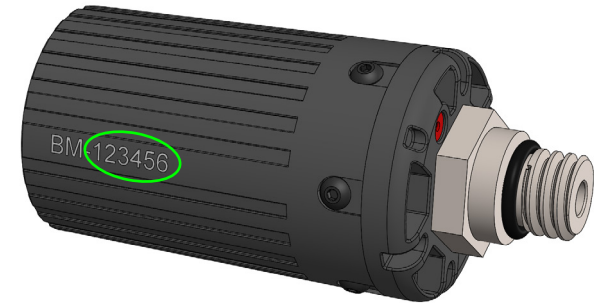

Pair the transmitter by going to the **T1 Setup** menu option. Then, enter the 6-digit serial number into the **T1 Serial #** setting. You only need to set this once, as it will be permanently saved in the settings memory.

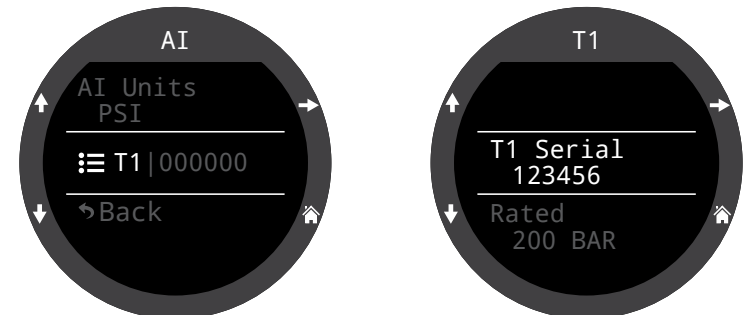

More information about settings in the [T1 & T2 Settings menu](#) can be found on page 72.



Add an AI display to the home screen

AI information is automatically displayed as an info screen when the AI feature is enabled, however, the main screen will not show AI information until manually added.

In OC Rec mode, when using the Big layout, the right Info Row slot can be customized to show AI information.

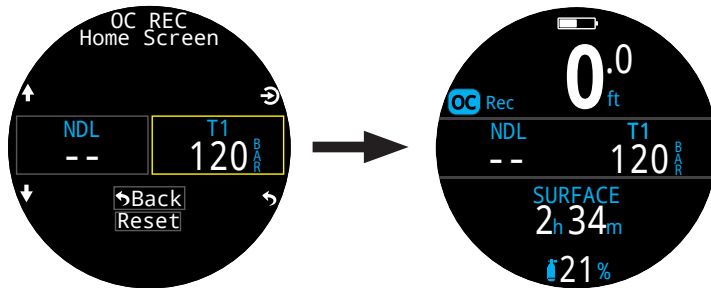

In any SCUBA mode, when using the Standard layout, the info row can be customized extensively to show AI information.

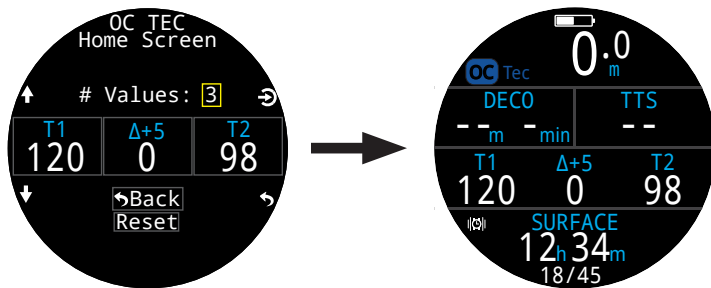

Use the **Settings > Dive > Home Screen** menu to add an AI display to your home screen.

Find more information about [Home Screen Customization](#) on page 21.



Check that your tank valve is open

Always take a few breaths from your regulator or purge your regulator's second stage while monitoring your tank pressure for a full 10-15 seconds prior to entering the water to ensure your tank valve is turned on.

If the first stage regulator is charged but the tank valve has been closed, the breathing gas available to the diver will decrease rapidly and within a few breaths the diver will face an "out of air" situation. Unlike an analog gauge, the air pressure reported on the Teric will only update every 5 seconds, so the pressure reported by the Teric must be monitored for longer than that (we suggest 10-15 seconds) to ensure the tank valve is open.

Including a regulator purge test followed by 10-15 seconds of air pressure monitoring before entering the water as part of your pre-dive safety check is a good way to mitigate this risk.



9.3. AI Displays

There are 4 display fields that are used to display AI information:

- 1) T1/T2 Pressure
- 2) GTR
- 3) SAC
- 4) Mini combination display



These displays can be viewed in two ways:

- 1) Added to a customizable zone on the home screen
- 2) Viewed on the AI info screen.

T1/T2 Pressure Display

The pressure displays are the most fundamental AI displays, showing pressure in the current units (PSI or Bar).

Normal T1/T2 Pressure Display:

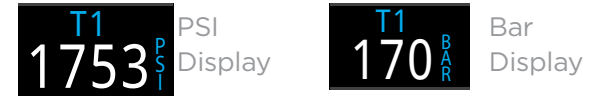

Low Pressure warnings:



Reserve Pressure thresholds can be managed in the AI settings. See [page 72](#) for details.

No Communication Warnings:



Low Transmitter Battery Warnings:





GTR Display

The Gas Time Remaining display shows the time, in minutes, that you could stay at the current depth until a direct ascent to the surface at a speed of 33 feet/min (10 m/min) would result in surfacing with the reserve gas pressure remaining.



The Value is displayed in yellow when less than or equal to 5 minutes. The value is displayed in red when less than or equal to 2 minutes.

GTR can only be based on a single tank. The title indicates which transmitter (T1 or T2) is being used for the GTR and SAC calculations in a dark gray font. When on the surface, the GTR displays “---”. **GTR is not shown when decompression stops are needed, and will display “deco”.**

SAC data from the first 30 seconds of each dive is discarded. It then takes an additional few minutes to calculate the average SAC. Therefore, for the first few minutes of each dive, the GTR will display “wait”, until enough data has been collected to begin making GTR predictions.

More information on how GTR is calculated can be found in the [GTR calculations section on page 51](#).



SAC Display

The Surface Air Consumption (SAC) display shows the average rate of pressure change over the last two minutes, normalized to as if at 1 ATA pressure. Depending on the current units setting, SAC is either displayed in PSI/minute or Bar/minute.



Note that SAC is NOT transferable between tanks of different sizes.

On the surface, the average SAC from the last dive is displayed.



During the first few minutes of a dive the SAC value is not available, while the initial data is being collected for averaging calculations. The SAC display will show “wait” during this time.

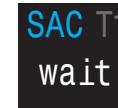

On surface, SAC is average from last dive

The average SAC from your last dive is shown when on the surface. When a dive ends, you may notice the SAC value suddenly changes. This is because the SAC display changes from showing the SAC over the last two minutes (when in dive mode) to showing the average SAC for the whole dive.



Mini Combination Display

A miniature combination display is available that packs more information into a smaller space, at the expense of font size.

AI Setting	Mini Display
Tx & GTR	T1 120 GTR 45
Tx & SAC	T1 120 SAC1.1
GTR & SAC	GTR 45 SAC1.1
T1 & T2	T1 120 T2 98

9.4. Using Multiple Transmitters

When using multiple transmitters, **best reception reliability will be attained when using transmitters of different colors.**

The different colors have different transmit timing. This prevents communication collisions that could potentially cause a loss of connection.

When two transmitters of the same color are used, the potential exists for their communication timing to become synchronized. When this occurs, the transmitters will interfere with each other, resulting in data dropouts. These dropouts may resolve quickly or could last up to 20 minutes or more.

By using different colored transmitters, the transmit timing periods are different enough that collisions due to synchronized communications will resolve quickly.

Shearwater sells standard gray transmitters, and also yellow transmitters with alternate transmit timing.



Using Multiple Transmitters of Same Color May Result in Lost Communications

Use different colored transmitters when using more than one transmitter (see above).

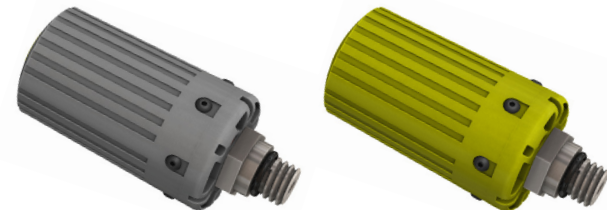

When using more than one transmitter, use one gray and one yellow for best reliability



9.5. SAC calculations

Surface Air Consumption (SAC) is the **rate of change of tank pressure**, normalized as if at 1 atmosphere of pressure. The units are either PSI/minute or Bar/minute.

The Teric calculates SAC averaged over the last two minutes. The data from the first 30 seconds of a dive are discarded to ignore the extra gas that is typically used during this time (inflating BCD, wing, or dry suit).

SAC vs RMV

Since SAC is simply based on rate of tank pressure change, the calculations do not need to know the tank size. However, this means that the SAC is NOT transferable to tanks of a different size.

Contrast this to respiratory minute volume (RMV) which is the volume of gas your lungs experience per minute, measured in Cuft/min or L/min. The RMV describes your personal breathing rate, and is therefore independent of tank size.

Why SAC instead of RMV?

Since RMV has the desirable property of being transferable between tanks of different sizes, it seems to be the better choice on which to base GTR calculations. However, the main drawback of using RMV is that it requires setting up tank size correctly for each tank. Such setup is easy to forget and is also easy to setup incorrectly.

SAC has the great property of not requiring any setup, making it the simplest and most reliable choice. The drawback is that it is not transferable between tanks of different sizes.

SAC Formula

The SAC is calculated as follows:

$$SAC = \frac{P_{tank}(t_1) - P_{tank}(t_2)}{t_2 - t_1} / P_{amb,ATA}$$

$P_{tank}(t)$ = Tank pressure at time t [PSI] or [Bar]
 t = Time [minutes]
 $P_{amb,ATA}$ = Ambient pressure [ATA]

The time samples are taken 2 minutes apart, and $P_{amb,ATA}$ is the average ambient pressure (i.e. depth) over this time frame.

Since the Teric displays and logs SAC, the formula for calculating RMV from SAC is useful. Knowing your RMV can help with planning dives using tanks of various sizes.

Calculating RMV from SAC - Imperial units

In the imperial system, tank sizes are described using two values; capacity in Cuft at a rated pressure in PSI.

For example, a common tank size is 80 Cuft at 3000 PSI.

To convert SAC in [PSI/minute] to RMV in [Cuft/minute], calculate how many Cuft are stored per PSI, then multiply this by the SAC to get RMV.

For example, a SAC of 23 PSI/min with an 80 Cuft 3000 PSI tank would be an RMV of $(23 \times (80/3000)) = 0.61$ Cuft/min.

Calculating RMV from SAC - Metric units

In the metric system, tank sizes are described using a single number, the tank's physical size in liters [L]. This is how much gas could be stored at a pressure of 1 Bar, so effectively the units of tank size are [L/Bar].

This makes converting SAC to RMV easy. When using metric units, simply multiply the SAC by tank size.

For example, a SAC of 2.1 Bar/min with a 10 L tank would be an RMV of $(2.1 \times 10) = 21$ L/min.



9.6. GTR calculations

Gas Time Remaining (GTR) is the time in minutes that can be spent at the current depth until a direct ascent to the surface at a rate of 10 m/min (33 feet/min) would result in surfacing with the reserve pressure. This is calculated using the current SAC value.

Safety stops and decompression stops are not considered by the GTR calculations.

To calculate GTR, start with the known tank pressure, P_{tank} . The remaining gas pressure, $P_{remaining}$, is determined by subtracting off the reserve pressure and the pressure used for the ascent.

$$P_{remaining} = P_{tank} - P_{reserve} - P_{ascent}, \text{ all tank pressures in [PSI] or [Bar]}$$

Knowing $P_{remaining}$, divide this by the SAC adjusted to the current ambient pressure to get GTR in minutes.

$$GTR = P_{remaining} / (SAC \times P_{amb,ATA})$$

Why aren't safety stops included?

Safety stops aren't included to simplify the meaning of GTR, and make it consistent across operating modes that do not include safety stops.

Managing enough gas for a safety stop is quite simple, especially since they require a relatively small amount of gas. For example, consider if your SAC was 1.4 Bar/min (20 PSI/min). At a depth of 4.5m/15ft, the pressure is 1.45 ATA. So a 3 minute safety stop would use $1.4 \times 1.45 \times 3 = 6.1$ Bar (87 PSI) of gas. This small amount of gas is easy to factor into the reserve pressure setting.

Why is GTR limited to one tank and no deco?

Currently, Shearwater does not believe that GTR is the proper tool for decompression dives, especially those involving multiple gases. This isn't to say AI in general

is not a good fit for all technical diving, but the GTR function becomes increasingly complex to manage and understand when multiple gases are used. For one, if multiple gases are used, then tank sizes must be correctly entered. This is a very easy step to forget, and will lead to incorrect GTR values. Multiple gas diving also requires further setup of associating each transmitter to a specific gas mixture, which besides being another setup to forget, gets complicated with corner cases such as having multiple tanks containing the same mixture. Further handling other situations such as only a subset of the used tanks with transmitters add complexity and potential for user misunderstandings. Overall, the extra complexity of menus and setup burden on the user would result in a system prone to mistakes and accidental misuse, and not fitting with Shearwater's design philosophies.

Gas management is an incredibly important and also complex activity, especially for technical diving. Education, training, and planning are critical for proper gas management for technical dives. Shearwater feels that a convenience feature such as GTR is not a good application of technology in this case, as its complexity and potential for misuse would outweigh its utility.

No compensation for ideal gas law deviations

Note that all SAC and GTR calculations assume that the ideal gas law is valid. This is a good approximation up to about 207 Bar (3000 PSI). Above this pressure, the change in gas compressibility as pressure increases becomes a noticeable factor. This is mainly an issue for European divers using 300 Bar cylinders. The end result is early in the dive, when pressures are above 207 Bar/3000 PSI, the SAC is over-estimated, resulting in under-estimation of GTR (although this is the good way to err, as it is more conservative). As the dive progresses and pressure drops, this problem rectifies itself and the numbers become more accurate.



10. Watch Mode

Watch Mode is the default mode for the Teric at the surface. If the computer is left in Dive Mode at the surface, it will timeout back to Watch Mode after 15 minutes.

In Watch Mode, the Teric's screen will always remain on. However, the Teric will auto turn off to preserve battery after 20 minutes if it detects no motion.

10.1. Date And Time

On the Teric, the date, time and other watch settings can be set in the Settings > Watch menu.

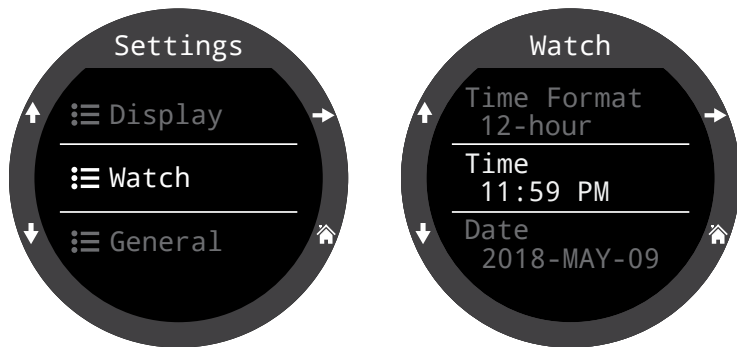

Details about Watch settings can be found in the Settings Menu Reference section on page 76.

Editing time resets stopwatch and timers. Alarms are not affected.

10.2. Watch Tools



All of the basic watch features can be found in the Watch Tools menu.

The watch tools can be accessed from the main menu in Watch Mode.

This section covers the details of the watch tools.

Alarms

Two independent alarms can be set.



Each alarm can be scheduled to go off:

- Once
- Everyday
- Weekdays
- Weekends

Each alarm has 4 notification options:

- Beeping
- Vibrating
- Beeping & Vibrating
- Visual Only



Alarms do not share notification settings with dive mode alerts

When an alarm is triggered, press either left button to cancel the alarm or either right button to snooze the alarm.

Snooze duration can be set in the Alarms Menu.



Timer

The Teric's timer can be edited to count down up to 10 hours.

Press EDIT (bottom left button) to modify the countdown length, or the notification type.



Timer Before Start



Edit Timer

The countdown time and notification setting for the timer are shown in gray at the bottom of the timer screen.



Timer Running



Timer DONE

Press the "+1" to add 1 minute to the countdown.

Press any button to Dismiss the DONE Notification.

The timer will run in the background and the DONE notification will sound even if the watch is "turned off".

Stopwatch

The Stopwatch is universal throughout the Teric. A stopwatch started in Watch Mode will continue in any diving mode until it is stopped.



While running, the word "Stopwatch" appears in Green.



When stopped, the word "Stopwatch" appears in Red.

The stopwatch appears on the home screen by default in gauge and Freedive Mode, but any dive mode can be customized to include it.



Stopwatch appears by default in freediving and gauge mode.



Stopwatch can be added to home screen in any mode.

The stopwatch has a 10 millisecond resolution and will run for up to 24 hours in the background, even if the Teric is "turned off".

When non-zero, the stopwatch can be reset. If running when reset, it continues running, counting up again from 0. If stopped when reset, then it is set 0 and remains stopped.



Flashlight

The flashlight simply turns the Teric screen on full brightness to provide an emergency source of light. It is only useful in the darkest of rooms or caves.

Watch Faces

Three watch faces are available for the Teric: Analog, Digital and Orbits.

The active watch face can be selected in the Watch Tools menu, or by default, it can be toggled by the function button in Watch Mode.

Each watch face can be displayed with various amounts of information.

Information levels can be quickly toggled by pressing the Info button.

10.3. Watch Face Colors

15 different watch face colors are available allowing over 100 possible watch face appearances.

Watch face colors can be selected in Settings > Display > Colors.

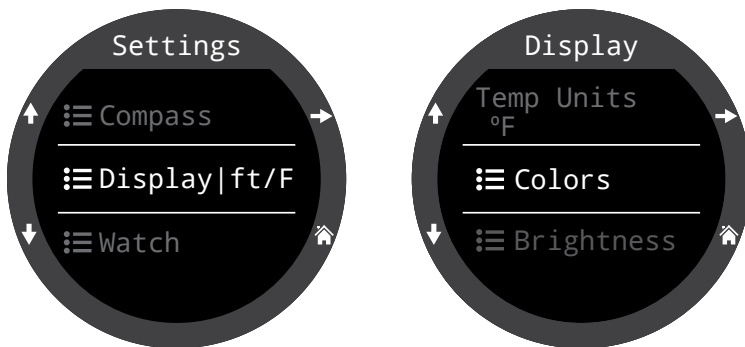

Analog

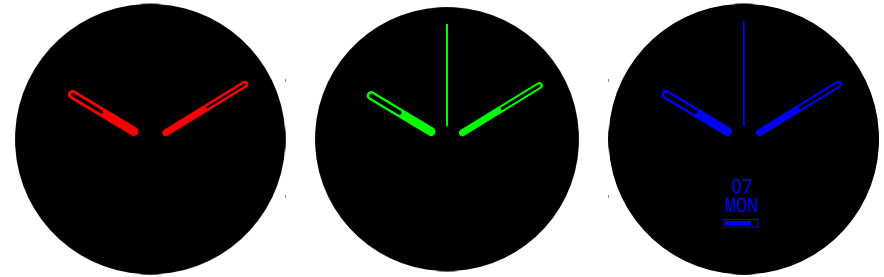

Digital



Orbits

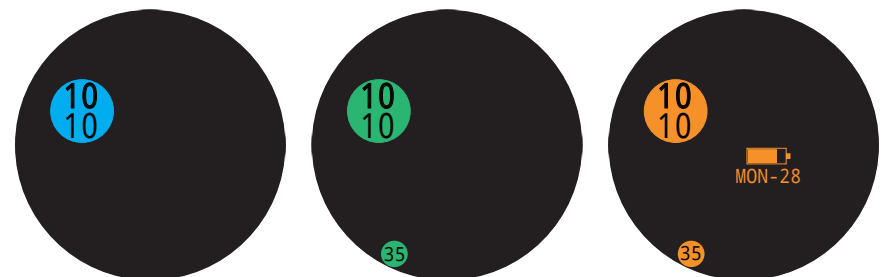

Over 100 possible watch face appearances can be created by selecting the watch face, information level, and watch face color.



11. Menus

Menus perform actions and allow settings to be changed.

All menus show button hints allowing easy navigation.

If no buttons are pushed for 1 minute, the menu system will time-out, returning to the main screen. Anything that had been previously saved will be retained. Anything that was in the middle of editing will be discarded.



Adaptive Menus

Only menus necessary for the current mode are shown. This keeps operation simple, prevents mistakes, and reduces button presses.

11.1. Main Menu

All Teric menus can be accessed from the main menu which can be brought up on any home screen by pressing the menu button.

Main menu items differ substantially by mode, as well as at the surface versus on a dive. The most commonly used menu items are placed at the top of the main menu to reduce button presses.

Main menu items are listed to the right by mode in the order they appear. In the following section each item will be covered in detail.

Note: Items in blue cells are only available at the surface.

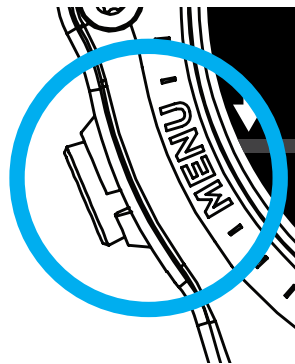

Menu items by mode:

WATCH	OC REC	OC TEC
Dive	Watch	Watch
Watch Tools	Select Gas	Select Gas
Alerts	Dive Tools	Dive Tools
Log	Edit Gases	Edit Gases
Bluetooth	Alerts	Alerts
Settings (s)	Log	Log
Off	Bluetooth	Bluetooth
Home	Settings	Settings
	Off	Off
	Home	Home

CC/BO	GAUGE	FREEDIVE
Watch	Watch	Watch
CC >> BO	Dive Tools	Change FD Set
SP 0.7 >> 1.3	Alerts	Edit FD Set
Select Gas	Log	Dive Tools
Dive Tools	Bluetooth	Alerts
Edit gases	Settings	Log
Set Points	Off	Bluetooth
Alerts	Home	Settings
Log		Off
Bluetooth		Home
Settings		
Off		
Home		



Dive / Watch



Toggles between the selected Dive Mode and Watch Mode.

Only available at the surface.

Watch Tools

Only available in Watch Mode.

All of the basic watch features including:

- Alarms
- Timer
- Stopwatch
- Flashlight
- Watch Face Selection

See [Watch Tools details on page 54.](#)

Dive Tools

Available in all dive modes both at the surface **and** during a dive.

Dive tools include

- Compass
- Stopwatch
- Tag Log
- Dive Plan
- NDL Plan
- Reset Average Depth
- Test Alerts

Not all tools are available in every mode. For example the dive planners are not available in Freedive Mode.

See [Dive Tools details on page 39.](#)

Switch to CC/BO

Depending on the current computer setting, this selection will show as either “CC >> BO” or “BO >> CC”.

Selecting this menu item will toggle the Teric to the displayed mode for decompression calculations. When switching to Bail Out while diving, the most appropriate Bail Out gas will become the breathing gas for calculations.

At this point, the diver may want to switch to a different gas, but since the diver may have other things to deal with, the computer will make a “best guess” of which gas the diver would choose.



Switch Set point (SP 0.7 >> 1.3)

CC mode calculates decompression for an unconnected rebreather. Set points are switched in the computer to approximate the rebreather set point.

During a dive the Switch Set point menu item will be the first item displayed in the main menu, since the “Watch” displays are disabled when diving.

Pressing SELECT when this menu item is displayed changes the PPO2 set point from the low set point to the high set point or vice-versa. To redefine the PPO2 value of a set point, use Main Menu > Set points.

The switch set point menu item performs a manual switching of the PPO2 set point. In the [Set Points](#) menu, the Teric can be setup to automatically perform set point switches at programmable depths. However, the Switch set point menu item is always available in CC mode to provide manual control.

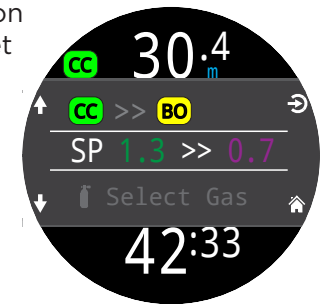

Select Gas

This menu item allows you to pick a gas from the gases you have created. The selected gas will be used either as the breathing gas in open circuit mode, or the diluent in closed circuit mode.

Gases are always sorted from most to least oxygen content.

Scroll up and down to select the desired diluent/gas, then press the SELECT button to select that diluent/gas.

An 'ACT' symbol will appear next to the currently active gas.

A gas that is off will be shown in **Magenta**, but can still be selected. It will be turned on automatically if it is selected.

Gases that are programmed but turned off are not used in decompression calculations.

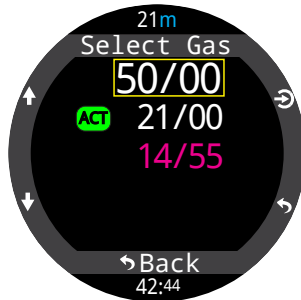
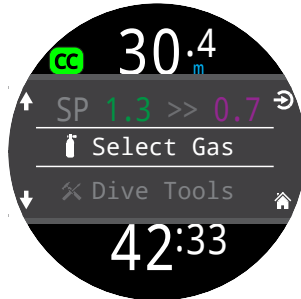

Gases will not turn off automatically

Selecting a new gas will turn that gas on if it is off, but gases will never turn off automatically.

It is important to turn off all gases you are not carrying and plan to use on the dive in the Edit Gas menu to ensure you receive accurate decompression information.



Radio Station Gases



The Teric CC/BO system maintains two sets of gases - one for open circuit and one for closed circuit.

The way they operate is very similar to the way car radios work with AM and FM stations.

When you are listening to an FM station and you push a station selection button, it will take you to another FM station. If you add a new station, it will be an FM station.

Similarly, if you are in the AM mode, adding or deleting a station would add or delete an AM station.

With radio station gases, when you are in open circuit, adding, deleting or selecting a gas will refer to an open circuit gas. Just like the FM stations are selected when your radio is in FM mode, the closed circuit gases are available in the closed circuit mode. When you switch to open circuit, the gases available will be open circuit gases.



Edit gases

The Edit gas function allows you to set up 5 gases for each of the 4 SCUBA modes:

- OC Rec
- OC Tec
- CC/BO
- Bailout

You must be in the mode you plan to use to edit gases for that mode.

For each gas, you can turn the gas on and off and select the percentage of oxygen and helium in the gas. The remainder is assumed to be nitrogen.

In OC Rec mode, only oxygen fraction can be edited. Trimix is unavailable in OC Rec mode.

Scroll through the gas list using the arrow keys and select the gas you wish to edit. The gas contents are edited one digit at a time. The yellow box shows the digit being edited.

Note: The “Act” denotes the active gas. You cannot delete the active gas. If you try, it will generate an error. You can edit it, but cannot set both the O2 and HE to 00.



Set Points CC

The Set Points menu is available in CC and BO mode on the surface and while diving. This menu allows you to define the high and low set point.

Values from 0.4 to 1.5 are permitted.



Change Freedive (FD) Set FD

Use this menu item to change between freedive sets.

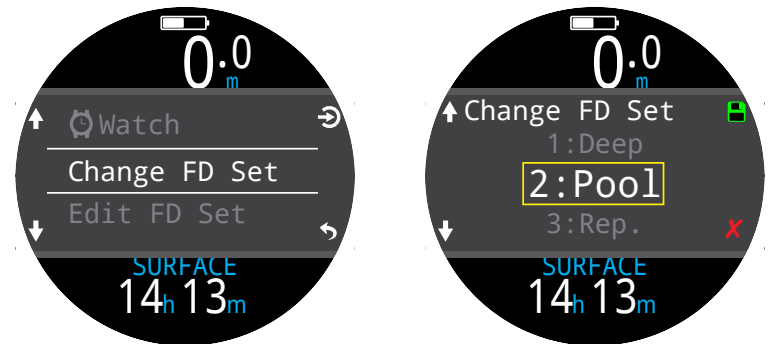

Turn off gases you are not carrying

The decompression algorithm assumes that the diver is carrying and plans to use every gas that is currently turned on. Leaving gases that are not expected to be used turned on will result in inaccurate time to surface, decompression stop and decompression time information being displayed.



Edit Freedive (FD) Set FD

Use this menu item to edit the current freedive set.

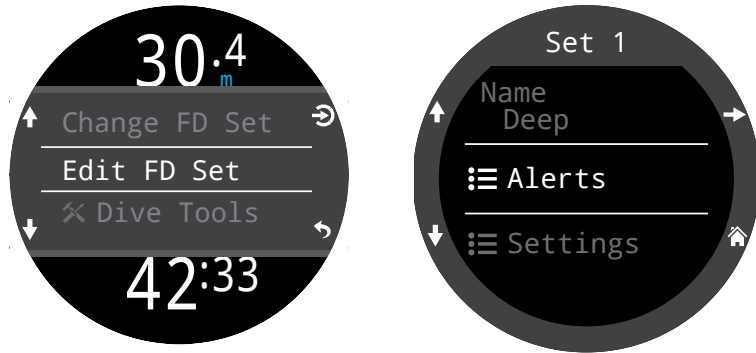

A freedive set is a collection of settings customized for a specific type of freediving.

Name

Allows the user to rename the freediving set. A FD Set Name can be up to four characters in length and appears next to the Freediving mode indicator when at the surface.



Default freediving sets are:

- Deep
- Pool
- Repetitive (Rep.)

Freediving Alerts

The freediving alert settings for the current Freedive Set can be defined here.

Freediving alerts are triggered by depth or time.

All Freediving alerts appear on the screen for 4 seconds or until they are cleared. Additionally each alert can have a custom auditory and vibration notification assigned to them.



Regularly test your alerts with the Test Alert tool described on page 41 to ensure they are working and you can hear/feel them through your exposure suit.

Freediving alert types:

Info - Appears in blue.



Warning - Appears in yellow.



Danger - Appears in Red



<i>Freediving Alert</i>	<i>Trigger Condition</i>	<i>Alert Type</i>
<i>Notify 1</i>	<i>Depth</i>	<i>Info</i>
<i>Notify 2</i>	<i>Depth</i>	<i>Info</i>
<i>Warn Depth</i>	<i>Depth</i>	<i>Caution</i>
<i>Max Depth.</i>	<i>Depth</i>	<i>Danger</i>
<i>Asc. Notify</i>	<i>Depth</i>	<i>Info</i>
<i>Notify Time</i>	<i>Time</i>	<i>Info</i>
<i>Warn Time</i>	<i>Time</i>	<i>Caution</i>
<i>Max Time</i>	<i>Time</i>	<i>Danger</i>
<i>Surf Time 1</i>	<i>Time</i>	<i>Info</i>
<i>Surf Time 2</i>	<i>Time</i>	<i>Info</i>
<i>Depth Repeat</i>	<i>Depth</i>	<i>Info</i>
<i>Time Repeat</i>	<i>Time</i>	<i>Info</i>
<i>Surf Repeat</i>	<i>Time</i>	<i>Info</i>



Set Settings

Water Type

Salt or fresh water. This setting affects depth readings because salt water is more dense.

Start Depth

The depth threshold for beginning a dive.

End Depth

The depth threshold for ending a dive.

Start Delay

The amount of time after crossing the start depth threshold before a dive is begun. Once a dive does begin, the length of the delay is added to the dive time to maintain accuracy.

End Delay

The amount of time after crossing the end depth threshold before a dive ends. Once a dive ends, the length of the delay is subtracted from the dive time to maintain accuracy.

Alerts

Available in all modes both at the surface and while diving.

Use this menu to set how the Teric will notify the user of an alert.

There are 4 modes:

- Silent Mode (no alerts)
- Beep Only
- Vibrate Only
- Beep and Vibrate

The current alert notification setting icon is shown next to “Alerts” in the main menu.

This setting is an override that applies to alerts in every dive mode.

The way dive events and warnings are communicated can be set up independently for each dive mode. See the Dive Settings “Alerts” section on page 67 to customize these alerts.

Note: timers, and alarms have their own notification settings for each individual timer/alarm and are not impacted by this setting.





Log

The on-board log can store about 400 hours of dive logs at the default 10 second log rate of the computer in OC Rec mode.



Scroll up and down on the first page of the log to see a list of all of your dives.

Select a dive (Top right button) to pan through dive detail screens.

Scroll up and down inside the dive detail screens to change the dive.

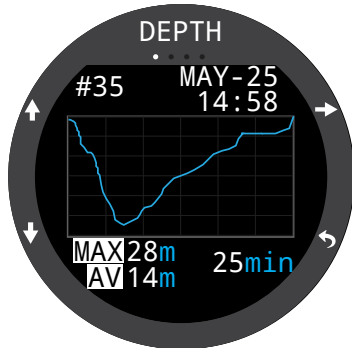

Log contents:

- Dive Number
- Dive Date and Time
- Max Depth
- Average Depth
- Dive Time
- Temperature Graph
- Starting and ending tank pressures
- SAC
- Dive Mode
- Surface interval
- Surface pressure
- Deco Settings
- Start & end CNS

Log Options

The Log options menu allows you to set the next log number to match your lifetime dive count.

From here you can also delete and restore deleted logs.

Bluetooth

Bluetooth is used for both firmware uploading and dive log downloading.

Use this option to initialize Bluetooth on your dive computer.

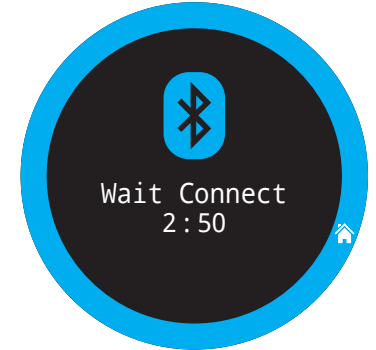
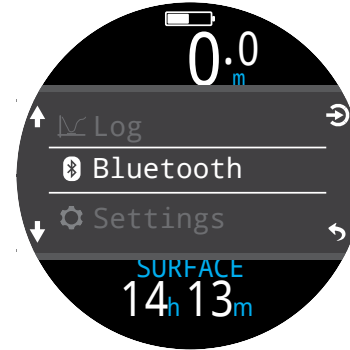

Off

The “Off” item puts the computer to sleep. While sleeping, the screen is blank, but the tissue contents are maintained for repetitive diving.

The “Off” menu item will not appear during a dive in any mode. It will also not appear after a dive until the dive End Dive Delay Time has expired or the dive has been ended manually to allow for a continuation dive.

End Dive

The “End Dive” menu item allows you to manually end the dive before the End Dive Delay has expire. This is useful if you have set a particularly long End Dive Delay and want to access the surface only features of the Teric quickly following a dive.



12. Settings Reference

The Settings menu can be accessed from the Teric's main menu when at the surface.

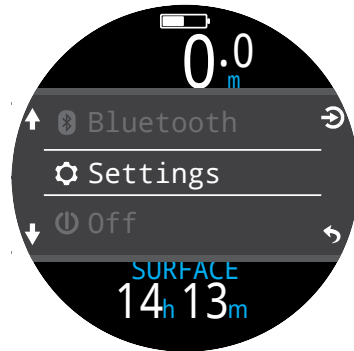

12.1. Dive Settings Menu

The first menu item within the settings menu is the Dive Settings Menu. This menu item also conveniently shows the current dive mode in gray.

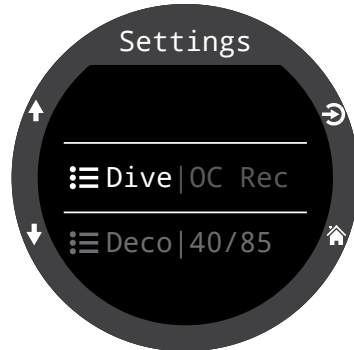

All of the settings in the Dive settings menu are isolated to the Dive Mode in which they were set.

So, if you customize your layout, home screen, and function button for OC Rec, then switch to OC Tec, when you switch back, your original OC Rec settings will be preserved.

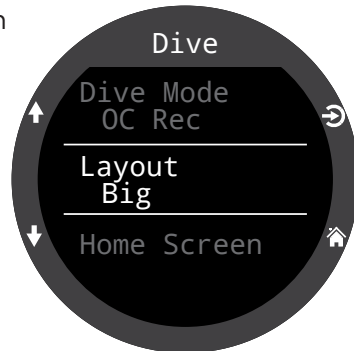

Dive Mode

There are 5 available dive modes:

- OC Tec
- OC Rec (default)
- CC/BO
- Gauge (e.g. bottom timer mode)
- Freedive

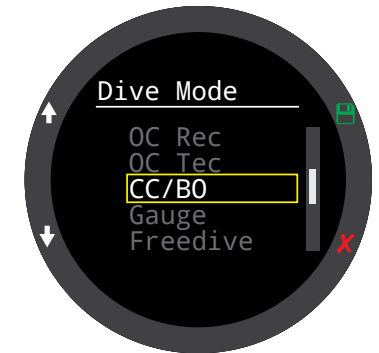

When changing to or from Gauge or Freedive Mode, the decompression tissues are cleared. This is because when in these modes the Teric does not know what gas you are breathing, and therefore cannot track inert gas loading. Plan repetitive dives accordingly.

For more information on which mode to choose, see [Dive Mode Differentiation on page 10](#).

Layout

The Layout menu item in the dive settings menu is used to select between the 2 available layouts: Big & Standard.

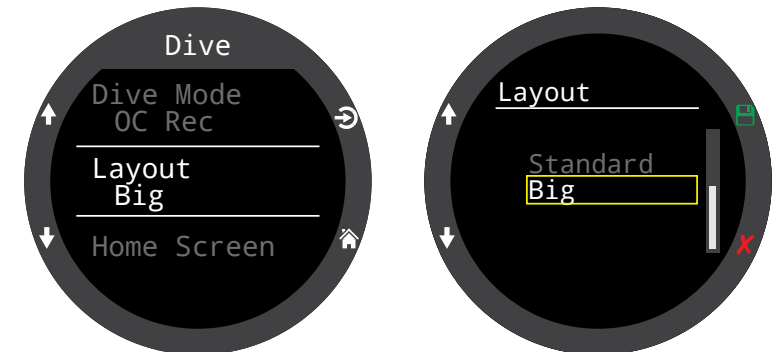

Like all of the other settings in the dive settings menu, this option is isolated to the dive mode in which it was set.

See the [Main Screen Layout section on page 11](#) for details about the different dive modes.



Home screen

This option is used to customize the Info row on the Home screen.

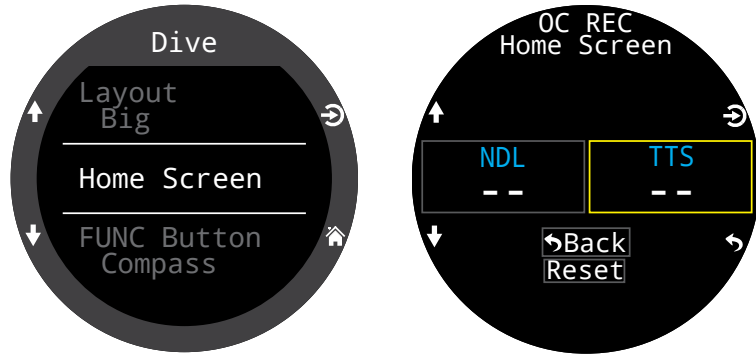

The Big layout (default for OC Rec mode) allows for customization of the right info row slot only because the left slot is taken by NDL which cannot be permanently obscured.

Note that in OC Tec and CC/BO modes, there is no customization available in the Big layout because we feel TTS should not be permanently obscured while decompression diving.

SELECT the right slot to bring up the list of options. Use the arrows to scroll through the available options. Press SELECT again to choose an option.

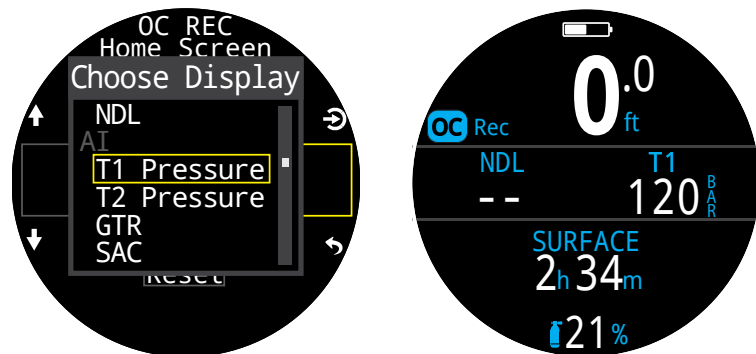

The Standard layout allows customization of the entire first page of the Info row.

Pick the number of elements you would like in the info row, then proceed to select which information you would like displayed in each position.

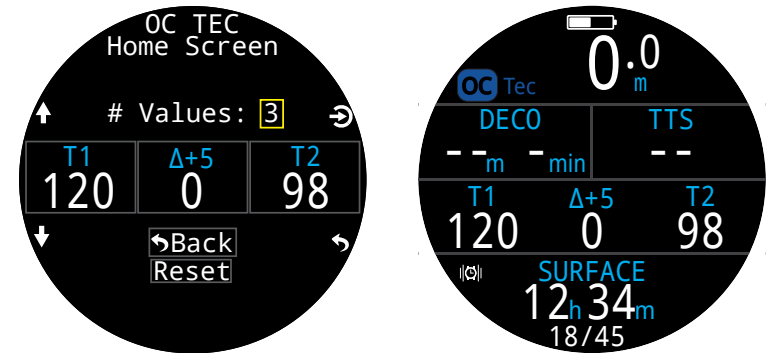

In CC/BO mode there is a separate Home screen menu item for each CC and BO. This allows you to optimize your bailout screen layout in advance, minimizing button pushes during an emergency.

[A complete list of Home Screen Customization options can be found on page 21.](#)

Watch the video:
[Home Screen Configuration](#)

Top-Right Disp

In OC Rec mode, the right Deco row slot of the standard layout can be customized like the Info row Home Screen.

All of the same customizaion options are available for this location.



FUNC Button

The function button (top right button) can be customized in every mode to act as a shortcut to your most commonly used tool.

Use the FUNC Button menu item in dive settings to choose the function button shortcut.

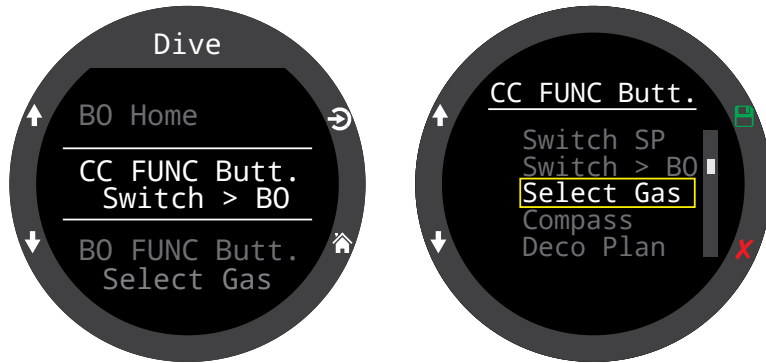

In CC/BO mode there is a separate function button shortcut for each CC and BO. This allows you to optimize computer's operation in advance, minimizing button pushes during an emergency.

Some options are only available in specific dive modes. Look for the corresponding mode icon indicating which mode each option is available in. No mode icons indicate the option is available in all dive modes.

In dive modes the FUNC button options are:

FUNC Setting	Description	
Switch SP	Toggles between high and low set points.	CC
Switch > BO	Changes dive mode to bail out.	CC
Switch > CC	Changes dive mode to closed circuit.	BO
Select Gas	Opens the gas select menu	CC OC Tec BO OC Rec
Compass	Opens Compass pop-up	
Deco Plan	Opens Dive planner	CC OC Tec BO OC Rec
Stopwatch	Opens the Stopwatch pop-up	
Tag Log	Opens Tag Log pop-up	
Home Screen	Quick return to home screen	
Rst Av Depth	Resets average depth	
No Action	No shortcut assigned	



Water Type

Water type (salinity) affects how the measured pressure is converted to depth. Settings:

- Fresh
- EN13319
- Salt

Density of freshwater and saltwater differ by about 3%. Saltwater, being denser, will display a shallower depth for the same measured pressure versus the Fresh setting.

The EN13319 value is between Fresh and Salt. It is from the European CE standard for dive computers, and is the Teric's default value.

End Dive delay

Sets the time to wait after surfacing before ending the current dive.

This value can be set from 10 seconds to 10 minutes. Default is 10 seconds.

This value can be set to a longer time if you want brief surface intervals connected together into one dive. Some instructors use a longer end dive delay when teaching courses. Alternatively, a shorter time can be used to exit dive mode more quickly upon surfacing.

Log Rate

Sets how often dive samples are added to the Teric's log. More samples will give a higher resolution dive log at the expense of log memory.

Default log rate in Freediving mode is 1 second. 10 seconds in every other mode.

Maximum log rate in Freedive Mode is 1/4 second. Maximum log rate in all other modes is 2 seconds.

Alerts

These settings allow you to modify your notification settings for warnings and dive events independently.

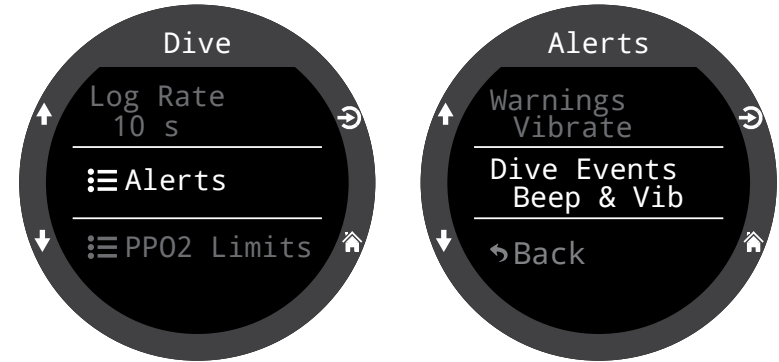

Note this is different from the top-level alerts menu. Those settings override these settings.

Like other attributes in the Dive Settings Menu, these alert settings are specific to the dive mode in which they were set.

There are 4 settings:

- Visual only
- Beep
- Vibrate
- Beep & Vibrate

For more information on the different types of alerts see the Alerts section on page 22.

For a list of alerts you might encounter see Warnings and Information Displays on page 83.

The Beeper setting changes the pitch of the Teric's beeper. The High Pitch option is louder, but a Low Pitch setting is also available for those who have a difficult time hearing higher frequencies.



PPO2 Limits

This section allows changing of PPO2 limits.



WARNING

Do not change these values unless you fully understand the effect.

All values are in absolute atmospheres [ATA] of pressure. (1 ATA = 1.013 Bar)

OC Low PPO2

PPO2 of all open circuit gases display in flashing red when less than this value. (Default 0.18)

OC MOD PPO2

This is the maximum allowable PPO2 during the bottom phase of the dive - **Maximum Operating Depth**. (Default 1.4)

PPO2 of the least oxygen rich mix that is turned on displays in yellow when within 0.03 of OC MOD PPO2.

PPO2 of the least oxygen rich mix that is turned on and the active gas display in flashing red when PPO2 is more than 0.03 greater than OC MOD PPO2.

Note: BO Mode never uses OC MOD PPO2

OC Deco PPO2

All decompression predictions (Deco schedule and TTS) assume that the gas used for decompression at a given depth will be the gas with the highest PPO2 that is less than or equal to this value. (Default 1.61)

Suggested gas switches (when the current gas is displayed in yellow) are determined by this value. If you change this value, please be sure you understand its effect.

For example, if lowered to 1.50, then a switch to oxygen (99/00) will not be assumed at 6m/20ft.

PPO2 of all gases except the least oxygen rich mix that is turned on display in yellow when within 0.03 of OC DECO PPO2.

PPO2 of all gases except the least oxygen rich mix that is turned on and the active gas display in flashing red when PPO2 is more than 0.03 greater than OC DECO PPO2.

CC Low PPO2

PPO2 displays in flashing red when less than this value. (Default 0.40)

CC High PPO2

PPO2 displays in flashing red when greater than this value. (Default 1.60)

Reset Limits

Resets all PPO2 limits for this dive mode back to defaults.

Note: In both OC and CC mode, a “Low PPO2” or “High PPO2” alert is displayed when the limits are violated for more than 30 seconds.



12.2. Deco Menu

The Deco Settings Menu provides options for adjusting the decompression algorithm.

Shown to the right of this item are the currently selected GF factors.

Like the Dive Settings Menu, any settings changed in this menu will only apply to the Dive Mode you are currently in.

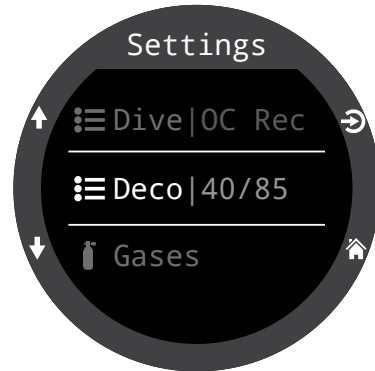

Deco Model

This will just show ZHL16C+GF indicating that the Bühlmann ZHL-16 with gradient factors model is being used.



GF Conserv.

3 preset conservatism levels are available. In order of increasing conservatism:

- Low (45/95)
- Med (40/85)
- High (35/75)

Medium conservatism is the default setting for OC Rec mode.

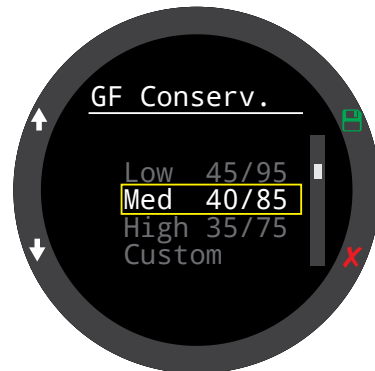

A custom GF option is also available in every dive mode.

When Custom is selected, fields for editing GF Low and GF High will appear in the Deco Menu.

OC Tec and CC/BO modes have a custom default of 30/70.

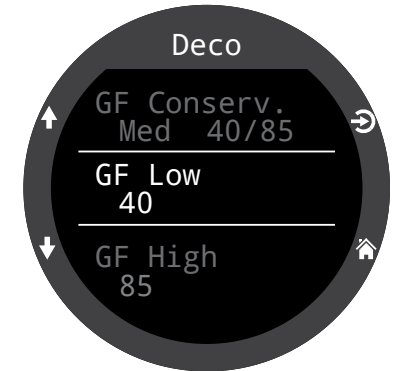

For a more detailed explanation of the GF algorithm and the meaning of GF Low and GF High, please refer to Erik Baker's excellent articles: **Clearing Up The Confusion About "Deep Stops"** and **Understanding M-values**. The articles are readily available on the web.

Also see the [Decompression and Gradient Factors](#) section on page 26.

Last Stop

Allows you to choose where to do your last stop. The choices are 3m/10ft and 6m/20ft. Note that this setting does not affect decompression. It only makes the TTS prediction more accurate.



Safety Stops

The Safety Stop setting is only present in OC Rec Mode. It can be set to the following values:

- Off
- 3 minutes
- 4 minutes
- 5 minutes
- Adapt
- Count Up



When using the Adapt setting, a 3 minute safety stop will be used, unless the dive exceeds 30m (100ft) or the NDL falls below 5 minutes, in which case a 5 minute safety stop is used.

[Read more about Safety Stops on page 24.](#)

Clear Counter

The Clear Counter setting is only available in OC Tec and CC/BO Dive Modes.

By default, the clear counter will count up from zero once decompression obligation has been cleared in OC Tec and CC/BO modes. It can be turned off here.



[Read more about Decompression Stops on page 25](#)

12.3. Gases

The Teric supports 5 programmable gases in OC Rec, OC Tec, CC, and BO dive modes.

This setting is the same as the Edit Gases item found in the main menu, but is conveniently located along with the other dive settings.

For a description of how to set each gas, please see the Edit Gases section on page 60.

In CC/BO mode, both the CC diluent and BO open circuit gas lists are directly accessible, eliminating the need to toggle between the two operating modes to check gases from the Edit Gases option in the main menu.

Note that OC Tec mode and BO mode share the same gas list. Editing one will edit the other.

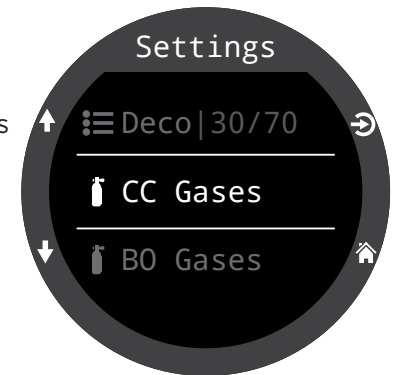
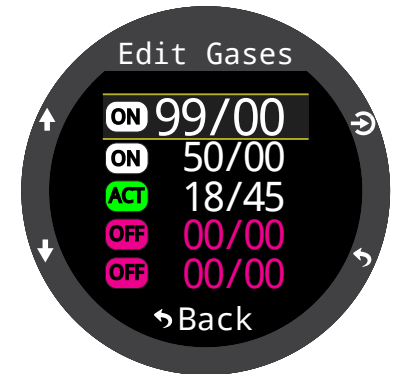
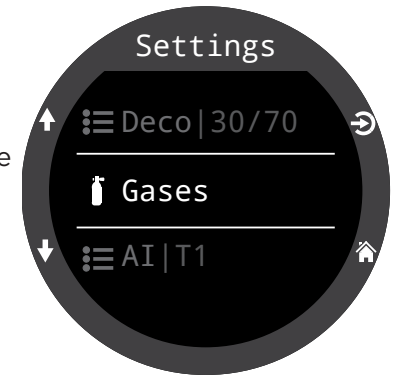



12.4. Set Points CC

This menu item is only available in CC/BO mode

High & Low Set points

Like the Set Points selection in the main menu, this menu allows you to edit your High and Low set points.

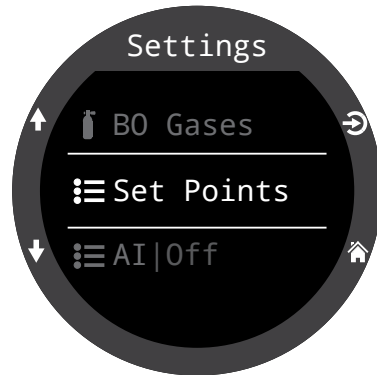

Auto Set Point switch

SP Auto Up and **SP Auto Down** are also available in this menu to set up automatic set point switching. They can be configured to auto switch up only, down only, both, or neither.

Use **SP Auto Up** to set whether the up switch occurs automatically or manually.

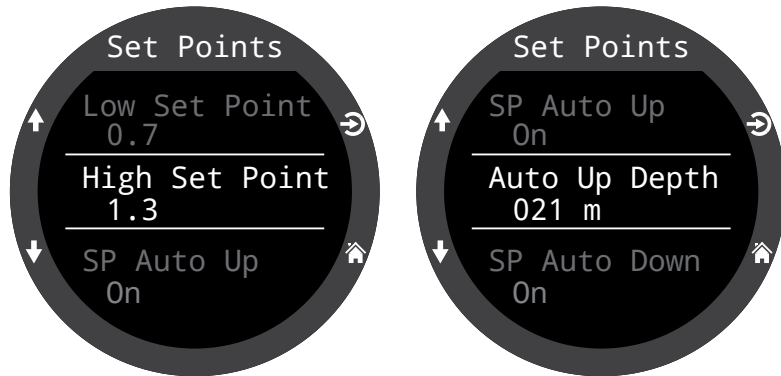

If **SP Auto Up** is set to "On", use **Auto Up Depth** to set the depth at which the auto switch occurs.

The menu options are the same for the down set point switch.

Example:

Up:	0.7 > 1.3	Auto Up Depth = 21m
Down:	1.3 > 0.7	Auto Down Depth = 5m

The dive starts at the 0.7 set point. As you descend past 21 m, the set point switches "up" to 1.3.

You finish your bottom time, then begin ascending. When you ascend above 5m, it switches "down" to 0.7.

When a switch is set to "Auto", you can always manually override the setting at any time during the dive.

The automatic switches only occur when crossing the specified depth. Say for example, the switch up depth is set to 15m. You start the dive on the low set point, then as you descend past 15m, the set point automatically switches up to high. If at say 24m you then manually switch back to the low set point, the set point will remain low. If you ascend shallower than 15m then re-descend deeper than 15m again, the automatic set point switch will occur again. The Teric enforces a 6m (20ft) gap between switch up and switch down depths to prevent rapid automatic switching between set points for small depth changes. The values 0.7 and 1.3 are shown as examples only. Other values for the low and high set point can be adjusted in the Set Points menu.



12.5. AI

All AI settings must be configured on the surface before a dive, since the settings menu is not accessible during a dive.

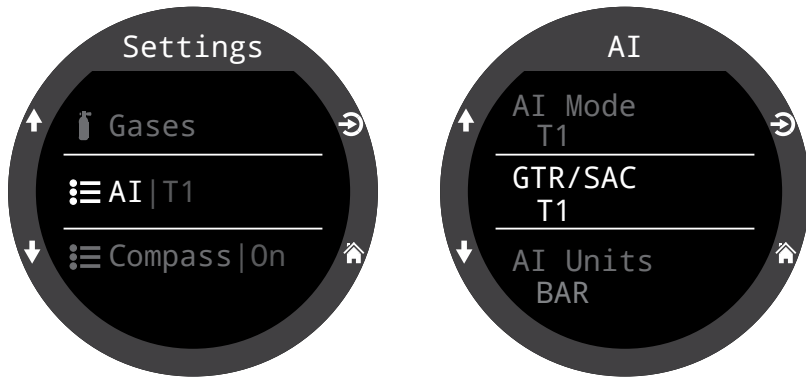

AI Mode

AI Mode is used to disable AI, or select which transmitters are active.

AI Mode Setting	Description
Off	AI sub-system is completely powered down and consumes no power. When on, AI increases power consumption by about 10%.
T1	Transmitter (tank) 1 is enabled.
T2	Transmitter (tank) 2 is enabled.
T1&T2	Both transmitters are enabled.



Set AI Mode to OFF when AI not in use

Leaving AI enabled when not in use will negatively impact battery life. When a paired transmitter is not communicating, the Teric goes into a higher power scan state. This increases power consumption to about 25% higher than with AI off. Once communications are established, power drops to about 10% higher than with AI off.

GTR/SAC

Gas Time Remaining (GTR) is the time in minutes that can be spent at the current depth and SAC rate until a direct ascent to the surface at a rate of 10 m/min (33 feet/min) would result in surfacing with the reserve pressure. The SAC rate is averaged over the last two minutes of diving for calculating GTR.

GTR/SAC is only based on one tank.

GTR/SAC Setting	Description
Off	GTR is disabled. SAC is also disabled.
T1	Transmitter (tank) 1 is used for GTR and SAC calculations.
T2	Transmitter (tank) 2 is used for GTR and SAC calculations.

GTR and SAC displays are described in the [AI Displays](#) section on page 49

Read more about how GTR is calculated on page 53.

Read more about how SAC is calculated on page 52.



T1/T2 Setup

The T1 & T2 menu pages allow setup that is individual to each transmitter/tank.

Serial Number Setup

Every transmitter has a unique 6-digit serial number. This number is etched onto the side of the transmitter.

Enter the serial number to pair the transmitter to T1. This number only needs to be entered once. Like all settings, it is stored in permanent memory. Transmitter settings are saved across all dive modes.

Reserve Pressure

Enter the reserve pressure

The valid range is 28 to 137 bar (400 to 2000 PSI).

The reserve pressure setting is used for:

- 1) Low pressure warnings
- 2) Gas Time Remaining (GTR) calculations

A **“Reserve Pressure”** warning will be generated when the tank pressure falls below this setting.

A **“Critical Pressure”** warning will be generated when the tank pressure falls below the larger of 21 Bar (300 PSI) or half the reserve pressure.

For example, if reserve pressure is set to 48 BAR, the critical warning will occur at 24 BAR (48/2). If the reserve pressure is set to 27 BAR, the critical warning will occur at 21 BAR.

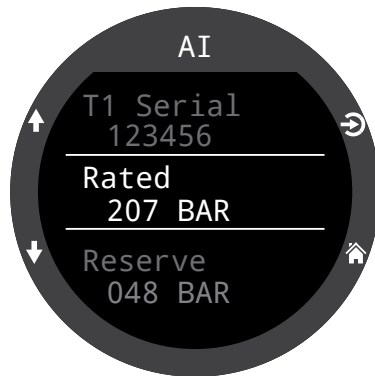
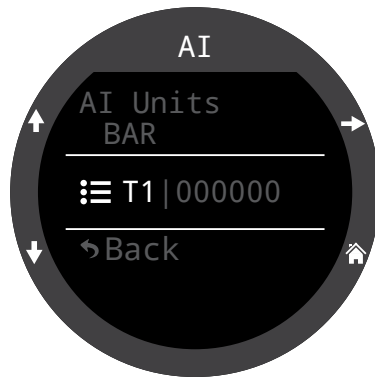

12.6. Compass

Enable

Disabling the compass will prevent it from being displayed in the info row. The display refresh rate can be reduced when the compass is not displayed on the screen, so disabling the compass allows a slight power savings (about 10%).

Outer Ring

Toggles the compass outer ring overlay. This can also be toggled from the compass pop-up. [More details can be found in the compass pop-up section on page 39.](#)

Declination

In most places, a compass does not point towards True North, but rather to Magnetic North. The difference in angle between these two directions is called the magnetic declination (also called magnetic variation), and varies around the world. The declination in your location can be found on maps or by searching on-line.

This setting can be set from -99° to +99°.

If you only need to match an uncompensated compass, or your navigation is all based on relative directions, then this setting is not necessary and can be left at 0°.

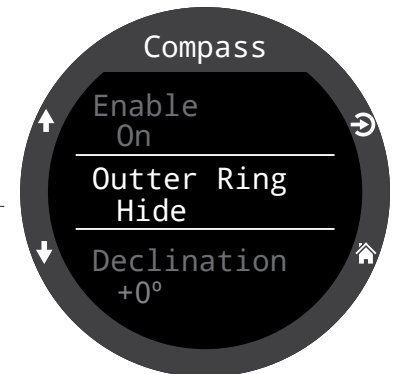
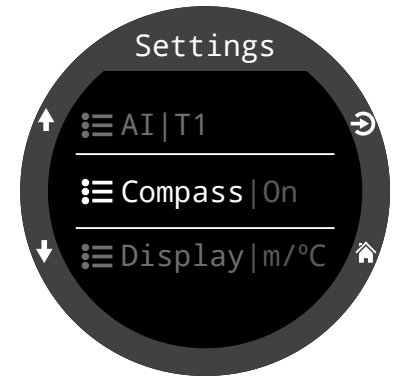



Calibrate

Calibration of the compass may be needed if the accuracy drifts over time or if a permanent magnet or ferromagnetic metal (e.g. iron or nickel) object is mounted very close to the Teric. To be calibrated out, such an object must be mounted with the Teric so that it moves along with the Teric Display.

Compare the Teric with a known good compass or fixed references to determine if calibration is needed. If comparing against fixed references, remember to consider the local deviation between Magnetic North and True North (declination).

Calibration is typically not needed when traveling to different locations. The adjustment needed then is the True North (declination).

When calibrating, rotate the Teric smoothly through as many 3D twists and turns as possible in 15 seconds. Keep metal and magnetic objects away during calibration. The calibration can also be reset back to the factory values. After calibration, it is recommended to compare the compass accuracy with a known good compass or fixed references.

Tips for a good compass calibration

- Stay away from metal objects. For example, wrist watches, metal desks, boat decks, desktop computers, etc. can all interfere with the Earth's magnetic field.
- Rotate to as many 3D positions as possible. Upside down, sideways, on edge, etc.
- Compare with another compass (not a smart phone as those are terrible) to check your calibration.

12.7. Display

Depth and temperature units are displayed in the display settings menu option.

Depth Units

Configurable to Feet or Meters.

Temp. Units

Configurable to °F or °C.

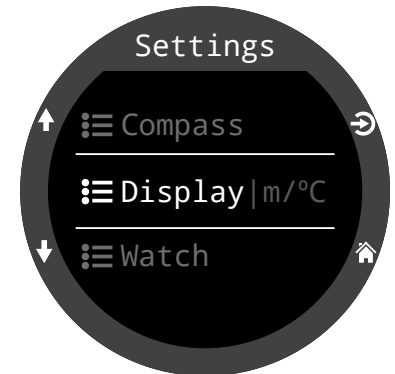

Colors

Teric display colors can be changed for added contrast or visual appeal.

Themes

4 preset color themes are available:

- Standard
- Sunlight
- Night
- Predator

Themes apply presets that quickly change the overall look of the Teric UI.

In addition to these preset themes, the Teric's color scheme can be extensively customized. Choose the "Standard" theme option to reset the colours to defaults.

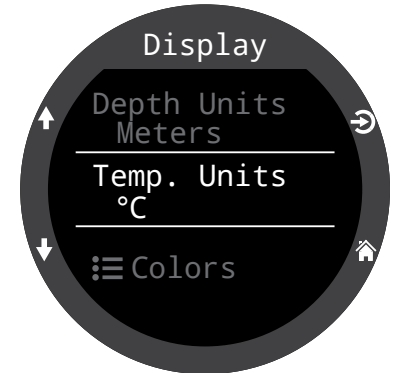



Customize Colors

Values, Titles, Units, Menu text, and Watch Face colors can all be customized from this menu.

15 color options are available.

Color Options:

- White
- Red
- Green
- Blue
- Cyan
- Magenta
- Yellow
- Orange
- Pink
- Lime
- Pastel Green
- Grapefruit
- Ice
- Violet
- Purple

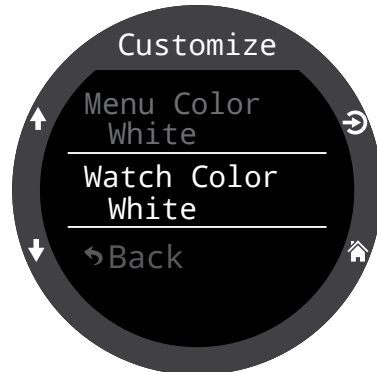
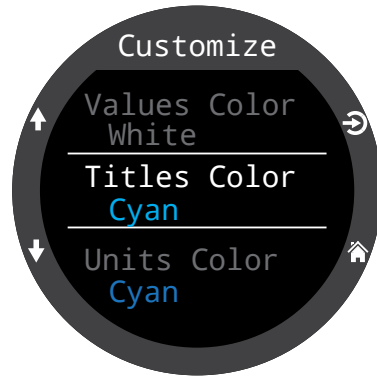

Brightness

Brightness

This setting does the same thing as the LIGHT (top right) Teric button

Screen brightness can be set to one of four fixed levels.

Options:

Dim: Made specifically for cave conditions.

Low: Second longest battery life.

Med: Best mix of battery life and readability.

High: Easiest readability, especially in bright sunlight.

Levels

This setting defines how many brightness levels are cycled through when pressing the LIGHT button. It also effects how many brightness levels are visible in the Brightness menu setting above.

Include Off

This setting determines if OFF is available as an option when the LIGHT button is pressed.

The battery life of the Teric is dramatically improved when "Off". This is a convenient feature if you forget your Teric charger at home and are being judicious with battery consumption.





12.8. Watch

Time Format

There are two available options for time format:

- 12-hours
- 24-hours

Time

Time on the Teric is set here.

Date

Date on the Teric is set here.

Time Zone

Setting the time zone can make it easier to adjust the time while traveling. Consult the table below to find the UTC time for the location nearest you.

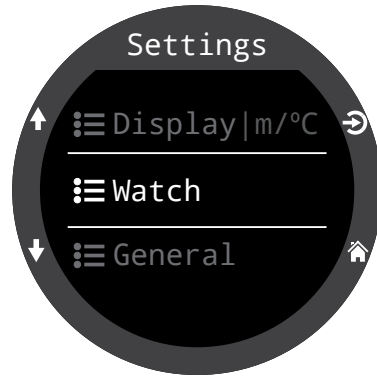

UTC Time Zone	Location
+13:00	Tonga
+12:00	Auckland
+11:00	Solomon Islands
+10:00	Sydney
+9:00	Tokyo
+8:30	North Korea
+8:00	China
+7:00	Bangkok
+6:00	Dhaka
+5:45	Nepal
+5:30	Mumbai
+5:00	Karachi
+4:30	Kabul
+4:00	Seychelles
+3:30	Tehran

UTC Time Zone	Location
+3:00	Istanbul
+2:00	Cape Town
+1:00	Paris
0:00	London
-1:00	Azores
-3:00	Rio de Janeiro
-4:00	Halifax
-5:00	New York
-6:00	Mexico City
-7:00	Denver
-8:00	Los Angeles
-9:00	Anchorage
-10:00	French Polynesia
-11:00	American Samoa

Daylight Savings

Simply adds one hour to the time without needing to change the timezone.

FUNC Button

Set the Function button shortcut for Watch Mode.

FUNC button options

The function button has different options that can be independently set for each mode. In Watch Mode, there are eight function button options.

FUNC Setting	Description
Watch Face (Default)	Cycles the watch face between Digital, Analog, and Orbits.
Flashlight	Turns on the flashlight function
Alarms	Brings up the alarms menu
Stopwatch	Opens the Stopwatch pop-up
Timer	Opens the timer pop-up
Turn Off	Turns Teric Off
No Action	No shortcut assigned



12.9. General

User Info

Use this menu to change the information presented on the Owner Info screen.

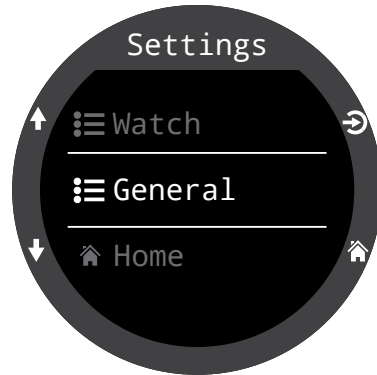

Battery

Quick Charge

When enabled Quick charge charges the watch a little bit faster. However, not all USB ports supply sufficient current for quick charge.

Quick Charge is disabled by default. If you've enabled quick charge and you're having problems charging your Teric, disabling quick charge may help.

Defaults

This will reset all user changed options to factory settings and / or clear the tissues on the Teric. A reset to defaults cannot be reversed.

Note: This will not delete dive logs, or reset dive log numbers.

System Info

The System Info section lists the computer's serial number as well as other technical information you may be asked to provide to tech support for troubleshooting purposes.



13. Firmware Update and Log Download

It is important to keep the firmware on your dive computer up to date. In addition to new features and improvements, firmware updates address important bug fixes.

There are two ways to update the firmware on your Teric:

- 1) With Shearwater Cloud Desktop
- 2) With Shearwater Cloud Mobile

Please note that Teric does not support the original Shearwater desktop application.



Upgrading the firmware resets decompression tissue loading. Plan repetitive dives accordingly.



During the update process, the screen may flicker or go blank for a few seconds

13.1. Shearwater Cloud Desktop

Ensure you have the most recent version of Shearwater Cloud Desktop. [You can get it here.](#)

Connect to Shearwater Cloud Desktop

On your Teric, start Bluetooth by selecting the Bluetooth menu item from the main menu.

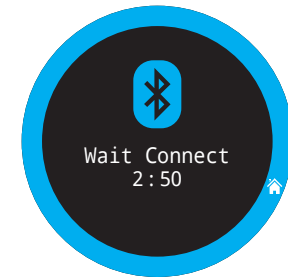
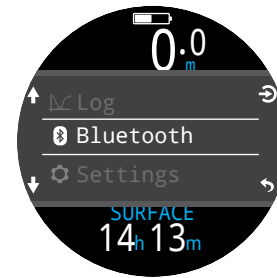

In Shearwater Cloud Desktop:

1. Click the connect icon to open the connect tab.
2. Scan for Dive Computer
3. Once you've connected the computer once, use the Teric tab to connect faster next time

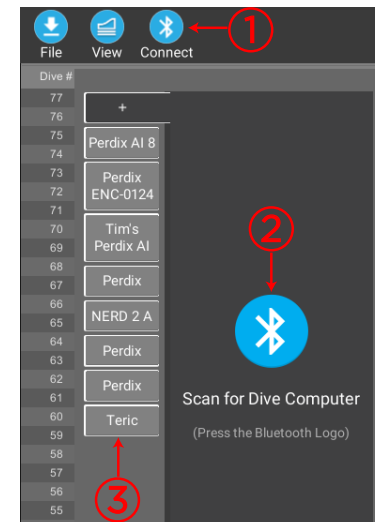

Shearwater Cloud Desktop Connect Tab

Once the Teric is connected, the connect tab will show a picture of the dive computer.

Download Dives

Select “Download Dives” from the connect tab.

A list of dives will be generated, and you can un-select any dive logs you don’t want to download, then press OK.

Shearwater Cloud Desktop will transfer the dives to your computer.

The first time you download dives from your Teric, you will be asked to give the Teric a name. If you have multiple Shearwater dive computers, you will be able to easily tell which dive was downloaded from which dive computer.

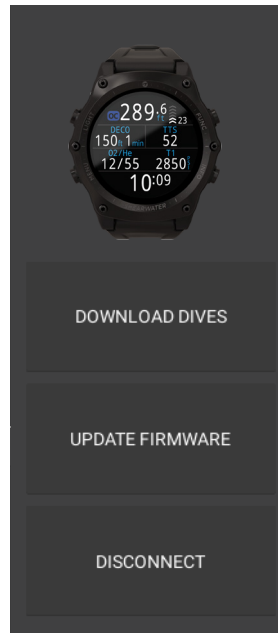

Shearwater Cloud Desktop Connect Tab



Select the dives you wish to download and press OK



Update Firmware

Select “Update Firmware” from the connect tab.

Shearwater Cloud Desktop will automatically select the latest available firmware.

When prompted, select your language and confirm the update.

The Teric screen will give percentile updates of receiving the firmware, and then the Personal Computer will read “Firmware successfully sent to the computer” on completion.



Firmware updates can take up to 15 minutes.



13.2. Shearwater Cloud Mobile

Ensure you have the most recent version of Shearwater Cloud Mobile.

Download it from [Google Play](#) or the [Apple App Store](#).

Connect to Shearwater Cloud Mobile

On your Teric, start Bluetooth by selecting the Bluetooth menu item from the main menu.

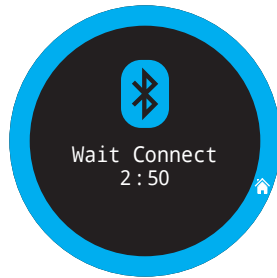
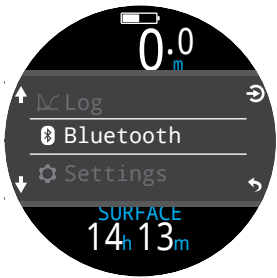

On Shearwater cloud mobile:

1. Press the connect icon at the bottom of the screen
2. Select your teric from the list of bluetooth devices

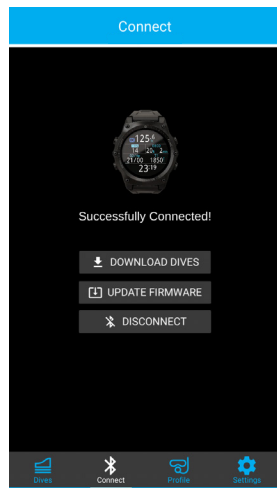

Download Dives

Select “Download Dives”

A list of dives will be generated and you can un-select any dive logs you don’t want to download, then press OK.

Shearwater Cloud will transfer the dives to your smart phone.

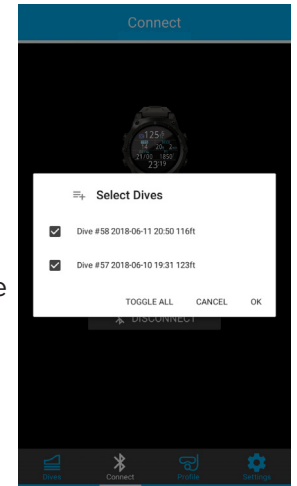

Update Firmware

Once the Teric is connected to Shearwater cloud mobile, select “Update Firmware” from the connect tab.

Shearwater Cloud mobile will automatically select the latest available firmware.

When prompted, select your language and confirm the update.

The Teric screen will give percentile updates of receiving the firmware, and then the mobile app will read “Firmware successfully sent to the computer” on completion.

Firmware updates can take up to 15 minutes.



14. Teric Strap

The included Teric strap is a durable, stretchy silicone designed to grip a wet suit or dry suit without sliding around. Various strap options are available.



For extra length, use the included extender strap.

The strap is fastened to the Teric via stainless steel watch lugs which can be easily removed and replaced with two standard 1.5mm hex screwdrivers (included).

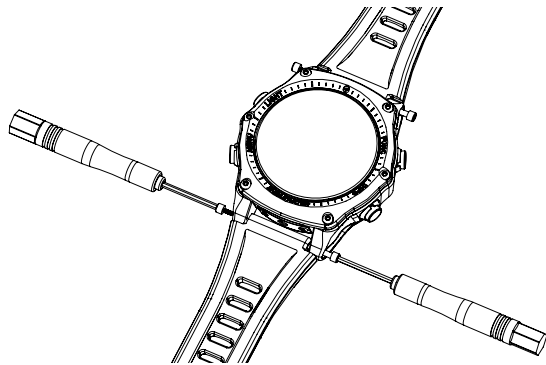

The Teric is compatible with most 22mm off the shelf straps for unlimited customizability.



DO NOT OVER TORQUE LUG SCREWS

Once it feels tight, stop screwing. Over torquing can damage screw threads.

Additional lug screws are included in the box.

15. Charging

The Shearwater Teric charges wirelessly when mounted on the included dock and on some third party wireless Qi compliant chargers.

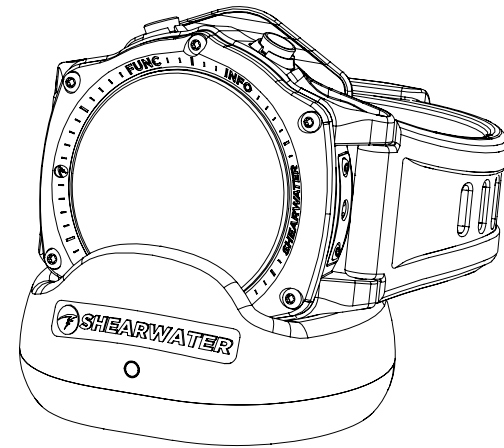

The Teric screen rotates 90 degrees for easy viewing of the time when the Teric is mounted on the charger.

The screen will turn off after 20 seconds to preserve the long term health of the screen and battery, but pressing any button will wake up the Teric so the time can be viewed.

The SUN button will adjust the screen brightness and the OFF button will turn the screen off.

Dive Mode functions are not available while the Teric is charging.



Charger Positioning

Wireless chargers quickly lose efficiency when the transmission and receiver coils are not aligned properly or there is too large an air gap.

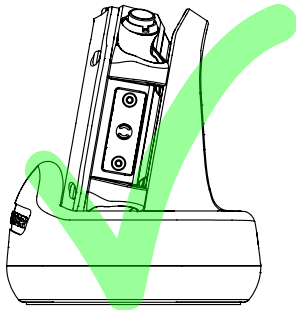

*Correct positioning
on charger - no gap*

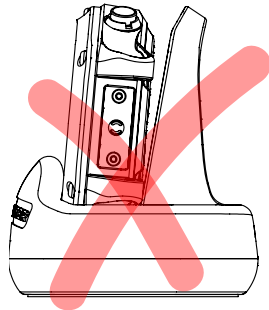

*Incorrect positioning
on charger - air gap*

Ensure the Teric is flat against the charging dock for the fastest, most efficient charge.

If the Teric stops charging and the charger light begins to flash red, remove and replace the Teric and charging should resume.

Battery Care

Lithium-ion batteries, such as the one in the Teric, can be damaged if completely discharged. The Teric has internal protection which disconnects the battery before complete discharge occurs. However, a small amount of self-discharge still occurs, which can lead to complete discharge and subsequently battery damage if stored for long periods without recharging.

To prevent damage to the battery please do the following:

- 1) Fully charge the Teric prior to storage
- 2) Top up the Teric battery every 6 months

Charging time

The Teric can be charged with any USB wall power adapter or with a computer. Charging time is approximately 1.5 hours with Quick Charge enabled, and 3-4 hours without.

Behavior on Dead battery

Settings

All settings are retained permanently. No loss of settings occurs if the battery dies.

Clock

The clock (time and date) data will be lost if the Teric experiences a total loss of power.

Once the battery is charged, you will need to update the Clock and Date in the Settings > Watch Menu.

The Teric uses a highly accurate quartz crystal for time keeping. Expected drift is about 1 minute per month. If you notice drift, it is easily corrected in the Settings > Watch menu.

Decompression tissue loading

If the battery dies between repetitive dives the decompression tissue loading will be lost.

Plan repetitive diving accordingly.

When deco tissues are reset, the following are also reset:

- Inert gas tissue loadings set to saturated with air at current atmospheric pressure
- CNS Oxygen Toxicity set to 0%
- Surface Interval time set to 0



16. Troubleshooting

Follow these guidelines to help solve problems with the Teric.

16.1. Warnings and Information Displays









The following table lists warnings and errors and information alerts you may see, their meaning, and steps to take to solve any problems.

The highest priority notification is listed first. If multiple alerts occur simultaneously, the error with the highest priority will be displayed. Clear that error by pressing the INFO button to see the next error.

See the Alerts section on page 22 for more information.

Contact Shearwater

The subsequent list of warnings, errors and notifications is not exhaustive. Please contact Shearwater if you experience any unexpected errors: info@shearwater.com

Display	Meaning	Action to take
	The PPO2 is below the limit set in the PPO2 limits menu.	Change your breathing gas to one safe for the current depth.
	The PPO2 is above the limit set in the PPO2 limits menu.	Change your breathing gas to one safe for the current depth.
	A required decompression stop was violated.	Descend deeper than the currently displayed stop depth. Monitor for symptoms of DCS. Use extra conservatism for future repetitive dives.
	The ascent was sustained as faster than 10m/min (33ft/min)	Use a slow ascent rate. Monitor for symptoms of DCS. Use extra conservatism for future repetitive dives.
	The internal battery is low.	Recharge the battery.
	The decompression tissue inert gas loading has been set to default levels.	Plan repetitive dives accordingly.
	Central Nervous System (CNS) toxicity clock exceeded 150%	Switch to a gas with a lower PPO2 or ascend shallower (decompression ceiling allowing)
	Central Nervous System (CNS) toxicity clock exceeded 90%	Switch to a gas with a lower PPO2 or ascend shallower (decompression ceiling allowing)



Display	Meaning	Action to take
 + 	Tank pressure has fallen below the critical pressure.	Be aware that gas is running low. Begin to end your dive and perform a controlled ascent to the surface.
 + 	Tank pressure has fallen below the reserve pressure setting.	Be aware that gas is running low. Begin to end your dive and perform a controlled ascent to the surface.
 Alternates 	Low transmitter battery.	Replace the transmitter battery. See Transmitter Battery Replacement on page 85
	Decompression stops are required. OC Rec mode only.	Perform decompression stops as directed.
	NDL is less than 5 minutes. OC Rec mode only.	Ascend soon to avoid decompression obligation.
 Alternates 	No communications for 30 to 90 seconds.	See AI Connection problems on page 84
 Alternates + 	No communications for 90+ seconds.	See AI Connection problems on page 84
	GTR is not available when on the surface.	None. GTR will display during a dive.

Display	Meaning	Action to take
	GTR (and SAC) are not available for the first few minutes of a dive.	None. After a few minutes, enough data has been collected for display.

16.2. AI Connection problems

If you are seeing “No Comms” errors, follow these steps:

If the “No Comms” is persistent:

Check that the proper serial number is entered into the **AI Setup** → **T1/T2 Setup** menu. Ensure the transmitter is turned on, by connecting it to a first stage and turning on the tank valve. Applying high pressure > 50 PSI (3.5 Bar) is the only way to turn on the transmitter. The transmitter will power off after 2 minutes of no pressure. Bring the handset within range (3ft / 1m) of the transmitter. Having the transmitter too close (less than 2 inches / 5 cm) can also cause communication loss.

If the “No Comms” is intermittent:

Search for sources of radio frequency (RF) interference, such as HID lights, scooters, or photo flashes. Try eliminating such sources to see if this solves the connection problem.

- Check the distance from transmitter to handset. If range related dropouts are occurring during diving, locating the transmitter on short length of high pressure hose is possible to decrease the transmitter to handset distance.



17. Storage and Maintenance

The Teric dive computer and transmitter should be stored dry and clean.

Do not allow salt deposits to build up on your dive computer. Rinse your computer with fresh water to remove salt and other contaminants.

Do not wash under high pressure jets of water as it may cause damage to the depth sensor.

Do not use detergents or other cleaning chemicals as they may damage the dive computer. Allow to dry naturally before storing.

Store the dive computer and transmitter **out of direct sunlight** in a cool, dry and dust free environment. Avoid exposure to direct ultra-violet radiation and radiant heat.

17.1. Transmitter Battery Replacement

Transmitter battery type is 3V Lithium CR2.

1. Loosen the cap by turning counter-clockwise with a coin.
2. Remove old battery and discard according to local regulations on lithium batteries.
3. Install the new battery, positive end first.
4. Replace the o-ring (size AS568-016, nitrile A70) and lightly lubricate it with a silicone grease. When installing the o-ring, roll it over the lip from the coin slot side. Do not roll it over the threads.
5. Install the battery cap by turning clockwise. Start slowly to avoid cross-threading the cap. The cap should be flush with the case when properly installed.

18. Servicing

There are no user serviceable parts inside the Teric or transmitters. Do not tighten or remove the faceplate screws. Clean with water ONLY. Any solvents may damage the Teric dive computer.

Service of the Shearwater Teric may only be done at Shearwater Research, or by any of our authorized service centers.

Contact Info@shearwater.com for service requests.

Evidence of tampering will void your warranty!

19. Glossary

CC - Closed circuit. Scuba diving using a rebreather where exhaled gas is recirculated with carbon dioxide removed.

GTR - Gas Time Remaining. The time, in minutes, that can be spent at the current depth and SAC rate until a direct ascent to the surface would result in surfacing with the reserve tank pressure.

NDL - No Decompression Limit. The time, in minutes, that can be spent at the current depth until mandatory decompression stops will be required.

O₂ - Oxygen gas.

OC - Open circuit. Scuba diving where gas is exhaled into the water (i.e. most diving).

PPO₂ - Partial Pressure of Oxygen, sometimes PPO2.

RMV - Respiratory Minute Volume. Gas usage rate measured as the volume of gas consumed, adjusted as if at a pressure of one atmosphere. Units of Cuft/minute or L/minute.

SAC - Surface Air Consumption. Gas usage rate measured as the rate of tank pressure change, adjusted as if at a pressure of one atmosphere (i.e. surface pressure). Units of PSI/minute or Bar/minute.



20. Teric Specifications

Specification	Teric
Operating Modes	OC Tec OC Rec CC/B0 (internal PPO2) Gauge Freedive
Decompression Model	Bühlmann ZHL-16C with GF
Display	Full Color, Round 1.39" 400x400 AMOLED
Pressure (depth) sensor	Piezo-resistive
Calibrated Range	0 Bar to 14 Bar
Accuracy	+/-20 mBar (at surface) +/-100 mBar (at 14bar)
Crush Depth Limit	20 Bar (~200msw)
Surface Pressure Range	500 mBar to 1040 mBar
Depth of dive start	1.6m (adjustable in Freedive Mode)
Depth of dive end	0.9m (adjustable in Freedive Mode)
Operating Temperature Range	+4°C to +32°C
Short-Term (hours) Temperature Range	-10°C to +50°C
Long-Term Storage Temperature Range	+5°C to +20°C
Battery	Rechargeable Lithium Ion battery

Teric Specifications (cont.)

Battery	50 hours in dive mode.
Operating Life	3 months in Standby
Communications	Bluetooth Smart
Compass Resolution	1°
Compass Accuracy	±5°
Compass Tilt Compensation	Yes, 45° pitch and roll
Dive Log Capacity	Over 400 hour detailed log at 10s logging frequency. 2000 dive basic log
Wrist Attachment	22mm width silicone watchband.
Weight	120g
Size (W X L X H)	54.5mm x 53.5mm x 17.5mm





21. AI Transmitter Specifications

Specification	Transmitter
Wireless Range	3 ft (1 m)
Depth Rating	500 ft (150 m)
Pressure Range	0 to 4350 PSI (0 to 300 Bar)
Pressure Resolution	2 PSI (1 Bar)
Operating Temperature	22°F to 140°F (-6°C to 60°C)
Size	2.95" (V) x 1.38" (Diameter) 75mm (L) x 35mm (Diameter)
Weight	0.26 lbs (116g)
Packaged Size	3.74" (L) x 2.56" (W) x 2.17" (H) 95mm (L) x 65mm (W) x 55mm (H)
Packaged Weight	0.40 lbs (180g)
Battery Type	CR2 Lithium User replaceable
Battery Life	300 dive hours at two 1-hour dives per day Up to 5 year shelf life Annual replacement recommended
Battery Warning Levels	Warning (yellow) < 2.75V Critical (red) < 2.50V
Battery Cap O-ring	Size AS568-016, Nitrile (Buna-N) A70
High Pressure Fitting	7/16" UNF
High Pressure O-ring	Size AS568-012, Viton™ material
Turn-on conditions	Pressure > 120 PSI (8 Bar) Battery > 2.75 V
Turn-off conditions	Pressure < 50 PSI (4 Bar) for 2 minutes
Internal Over-Pressure Relief Valve	Yes

22. Regulatory Information

A) USA-Federal Communications Commission (FCC)

This equipment has been tested and found to comply with the limits for a Class B digital device, pursuant to Part 15 of FCC Rules. These limits are designed to provide reasonable protection against harmful interference in a residential installation. This equipment generates, uses, and can radiate radio frequency energy. If not installed and used in accordance with the instructions, it may cause harmful interference to radio communications. However, there is no guarantee that interference will not occur in a particular installation.

If this equipment does cause harmful interference to radio or television reception, which can be determined by tuning the equipment off and on, the user is encouraged to try and correct the interference by one or more of the following measures:

- Reorient or relocate the receiving antenna
- Increase the distance between the equipment and the receiver.
- Connect the equipment to outlet on a circuit different from that to which the receiver is connected.
- Consult the dealer or an experienced radio/TV technician for help.

Any changes or modifications not expressly approved by the party responsible for compliance could void the user's authority to operate the equipment.

Caution: Exposure to Radio Frequency Radiation.

This device must not be co-located or operating in conjunction with any other antenna or transmitter.

Teric Dive Computer Contains TX FCC ID: 2AA9B05

Pelagic Pressure Systems Transmitter Contains TX FCC ID: MH8A

B) Canada - Industry Canada (IC)

This device complies with RSS 210 of Industry Canada.

Operation is subject to the following two conditions:

- (1) this device may not cause interference, and
- (2) this device must accept any interference, including interference that may cause undesired operation of this device.

L'utilisation de ce dispositif est autorisée seulement aux conditions suivantes :

- (1) il ne doit pas produire d'interférence, et
- (2) l'utilisateur du dispositif doit être prêt à accepter toute interférence radioélectrique reçue, même si celle-ci est susceptible de compromettre le fonctionnement du dispositif.

Caution: Exposure to Radio Frequency Radiation.

The installer of this radio equipment must ensure that the antenna is located or pointed such that it does not emit RF field in excess of Health Canada limits for the general population; consult Safety Code 6, obtainable from Health Canada's [website](#).

Teric Dive Computer Contains TX IC: I2208A-05

C) EU - European Union Directives

- Gas pressure sensing components conform with EN250:2014- Respiratory equipment - requirements, testing and marking -clause 6.11.1 Pressure indicator for use with air, compliant with standard EN12021 (oxygen content of 21%) Certified by SGS Fimko Oy Ltd, P.O. Box 30 (Särkiniementie 3) 00211 Helsinki, Finland, Notified Body No. 0598.
- Depth and time measurements conform with EN13359:2000 - Diving Accessories - depth gauges and combined depth and time monitoring devices
- Electromagnetic compatibility conforms with EN61000-6-3:2007+A1:2011 - Radiated Emissions and EN61000-6-1:2007 - Electromagnetic Immunity
- EU Declaration of Conformity is available at: <https://www.shearwater.com/wp-content/uploads/2017/10/CE-conformity.pdf>
- Shearwater EU Representative: Narked at 90 Ltd. +44.1933.681255 Northamptonshire, UK info@narkedat90.com



23. Contact

Headquarters
13155 Delf Place, Unit 250
Richmond, BC
V6V 2A2
Tel: +1.604.669.9958
info@shearwater.com

US Service Center
DIVE-Tronix, LLC.
Snohomish, WA, USA
Tel: +1.858.775.4099
usaservice@shearwater.com

EU Service Center
Narked at 90 Ltd
15 Bentley Court,
Paterson Rd,
Wellingborough,
Northants, UK
NN8 4BQ

Tel: +44.1933.681255
info@narkedat90.com

Asia/Pac Service Center
Rob Edward
Wellington, NZ
Tel: +64.21.61535378
asiapacservice@shearwater.com

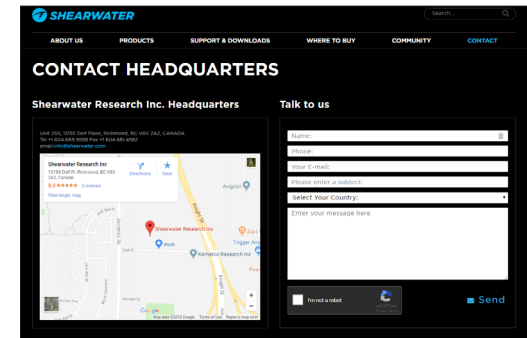

www.shearwater.com

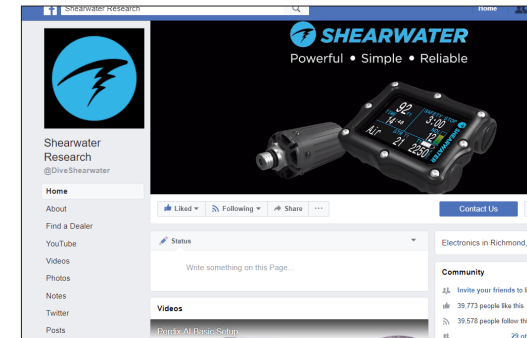

www.facebook.com/DiveShearwater

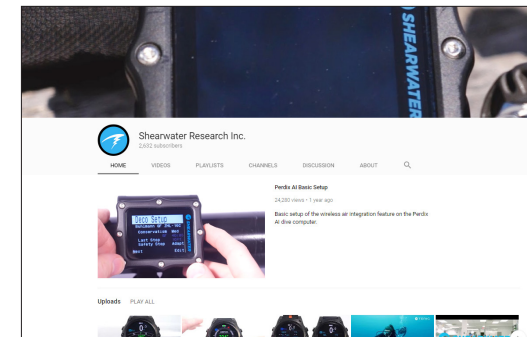

www.youtube.com/shearwaterresearch